

Best picture quality - JPEG2000

Stand-alone DVMR



16Channel Stand-alone DVMR

INSTALLATION & SAFEGUARDS

All the safety and operating instructions should be read before the unit is operated.

Environment Condition for Installation

- To prevent electric shock or other hazard, do not expose units to rain, moisture, or dust.
- This unit should be located in an area with low humidity and a minimum of dust..
- Place this unit in a well-ventilated place and do not place heat-generating objects on this unit.
- This unit should not be located in an area where it is likely to be subjected to mechanical shocks.

Before You Start

- Ensure the power switch is in the OFF position prior to starting.
- Do not attempt to service this unit yourself as opening or removing covers may expose you to dangerous voltage or other hazards.
- Installation should be performed by qualified service personnel only.
- This unit should be operated only from the type of power source indicated on the manufacturer's label and with the power supply included with the unit.

Notice

- Be aware you must first set the TIME/DATE, followed by setting the unit to the thoroughly about the power connection before installation of the unit.
(Please read Instruction for DC Power Adapter which is included in the package)
- Before initial configuration or operation FACTORY DEFAULT settings, lastly clearing the HDD. Please follow these steps in order.
- Before installing a second HDD, ensure that the drive conforms to the specifications listed on the specifications page at the end of this manual. When installing a second HDD, set the drive to SLAVE. After installation, first reset the TIME/DATE, followed by resetting the unit to the FACTORY DEFAULT settings, lastly clearing the new HDD.
- Pull the unit out of record mode prior to cutting power to the unit. Do this by entering the setup menu, followed by switching the unit off. Powering off the unit while writing to the disks can cause critical malfunctions. (ex: Recording Error, Playback Error, System Error)
- When you set the record type, you have to set the Record Configuration and also Schedule Setup. This unit records as per the Record type & Schedule setup.
- The [REC] button on the front panel is for emergency record using highest image quality.



The lightning flash with arrowhead symbol within an equilateral triangle is intended to alert the user of this equipment that there are dangerous voltages within the enclosure which may be of sufficient magnitude to constitute a risk of electric shock.



The exclamation point within an equilateral triangle is intended to alert the user to presence of important operating and maintenance(Servicing) instructions in the literature accompanying the appliance.

Contents

CHAP. 1	Features & Package Contents	-----	4
1-1.	Features	-----	4
1-2.	Package Contents	-----	5
CHAP. 2	Function of Each Button	-----	6
2-1.	Front	-----	6
2-2.	Rear	-----	8
CHAP. 3	Installation	-----	9
3-1.	Installation Configuration	-----	9
3-2.	Detailed Installation	-----	10
1)	Rack Mount	-----	10
2)	HDD(Hard Disk Drive)	-----	10
3)	Camera	-----	11
4)	Monitor	-----	11
5)	Power	-----	11
6)	VCR, Video Printer	-----	12
7)	Other External Device	-----	12
8)	Connector Pin Assignment	-----	13
9)	RS-232C ASCII-code	-----	13
CHAP. 4	Operation	-----	14
4-1.	System Log-in	-----	14
4-2.	Factory Default	-----	14
4-3.	Display Configuration	-----	15
4-4.	Live View Setup	-----	15
1)	Full / Multiple View	-----	15
2)	Sequencing Cameras	-----	16
3)	PIP View	-----	16
4)	Freeze View	-----	16
5)	Zoom View	-----	16
4-5.	Record	-----	17
4-6.	Playback	-----	17
4-7.	Search	-----	18

4-8.	PTZ Camera Operation	-----	19
4-9.	Data Back-Up	-----	19
CHAP. 5	Set Up	-----	20
5-1.	Entering the Menu	-----	20
5-2.	Display Setup	-----	21
1)	Screen Display	-----	21
2)	Monitor Setup	-----	21
5-3.	Configuration	-----	22
1.	HDD Management	-----	22
2.	TIME/DATE Setup	-----	23
3.	Camera Setup	-----	23
4.	Interval Setup	-----	25
5.	Alarm Setup	-----	25
6.	Buzzer Setup	-----	26
7.	Password Setup	-----	26
8.	System Information	-----	26
5-4.	Record Setup	-----	27
1.	Record Configuration	-----	27
2.	Schedule Setup	-----	28
3.	Holiday Setup	-----	28
5-5.	Back-Up	-----	29
5-6.	External Device	-----	29
1.	TCP/IP Setup	-----	30
2.	RS-232C Setup	-----	30
3.	Pan Tilt Zoom Setup	-----	30
5-7.	FACTORY Default	-----	31
5-8.	Language Setup	-----	31
CHAP. 6	Network Setup	-----	32
6-1.	DVR Network Configuration	-----	32
6-2.	Remote Viewer Program	-----	39
6-3.	Back-Up CD Player	-----	44
6-4.	FAQ	-----	46
CHAP. 7	Specifications	-----	49

CHAP. 1 Features & Package Contents

1-1. Features

Live View

Real time display per camera
Auto Sequence
PIP (Picture in picture)
Digital Zoom
Display Freeze
Simple Playback mode
Simple PTZ camera control

Record

Variable Record resolution (For higher picture quality or higher recording speed)
Efficient Image Quality setup in 5 steps
Schedule Record / Holiday Record
Event Record (Alarm / Motion)
Emergency Record

Network

View Live and Playback images across IP network
Copy images across the network

Playback

Search & Playback by Date/Time, Event and Camera
Outstanding picture quality by JPEG 2000 compression algorithm (No mosaic effect)
Suitable for recording not only images but also text
Various steps in Forward Playback Speed (X1/4, X1/2, X2, X4, X16, X60)
Various steps in Backward Playback Speed (X1/4, X1/2, X2, X4, X16, X60)
Easy and convenient search by Jog Shuttle & Remote Controller

Data Back-Up

Simple Back-Up using built-in CD Writer (Back-up CD Player included in the package)
Network Back-Up using Remote Viewer program (Remote Viewer included in the package)
Supports bigger capacity of HDD (300GB or bigger)

Others

Multi-Language (English, Spanish, Portuguese, German, French, Italy, Japan, China)
VGA option board supports both TFT LCD monitor and CRT monitor
Lock the system by Password
JOG / SHUTTLE
PAL/NTSC Auto detection
Control the unit by using Remote Controller

1-2. Package Contents

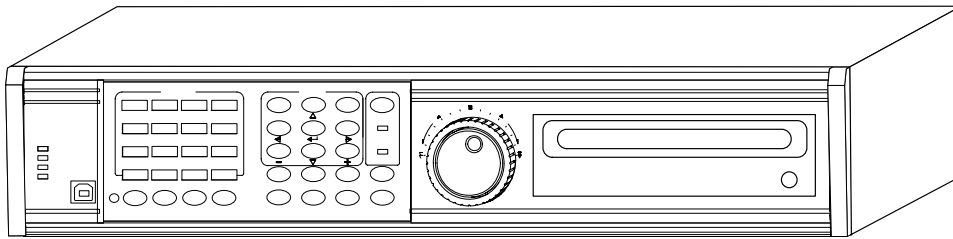

1. DVR Main Unit

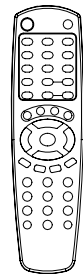

2. Remote Controller

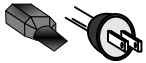

3. Power Cable

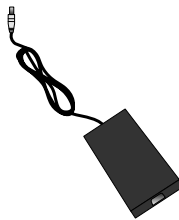

4. Power Adapter

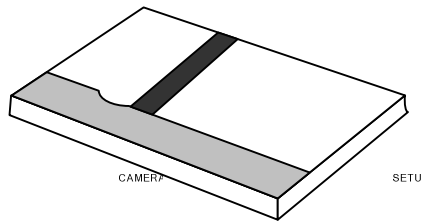

5. User's Manual

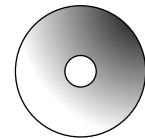

6. Software CD

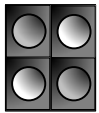

7. Rubber Pad

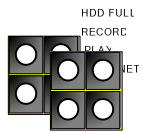

8. HDD absorber



9. Battery for remote controller

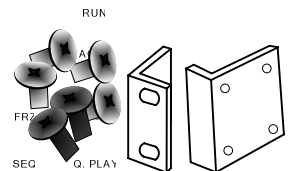

10. Bolts

Package Contents	Description
1. DVR Main Unit	STAND-ALONE DIGITAL VIDEO RECORDER
2. Remote Controller	DVR control
3. Power Cable	AC power supply to adapters for 12 V DC power
4. Power Adapter	12 V DC power supply
5. User's Manual	User's Manual
6. Software CD	Remote Viewer Software & Back up CD player
7. Rubber Pad	Prevent DVR from slipping. Attach it to the bottom of main unit
8. HDD absorber	Absorbing the mechanical shock of HDD against the case bottom
9. Battery	Battery for remote controller
10. Rack mount bracket / Bolts	Rack mount bracket
	For fixing Rack Mount bracket to DVR (6ea)
	For fixing DVR with Rack Mount bracket to 19" Rack (4ea)
	For fixing Hard Disk Drive into DVR (8ea)

CHAP. 2 Function of Each Button

2-1 FRONT

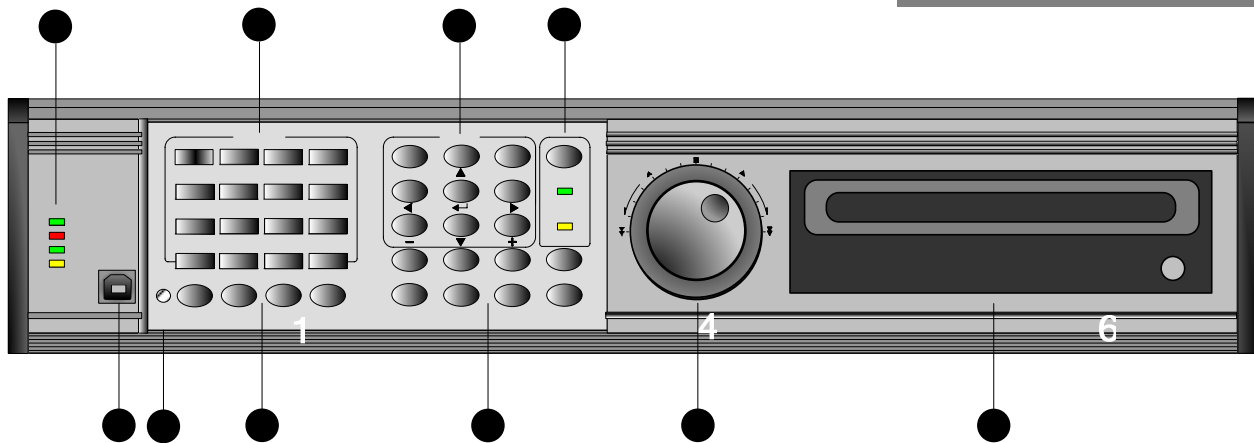

Name	Function	
① LED Lamps	Shows status of operation	
② USB Device	Firmware upgrade by connecting PC with latest firmware to USB port	
③ IR	IR receiver	
④ Camera selection & PTZ camera control	1. Pressing this button will display a full screen image of that camera	
	2. Control PTZ camera (Each button is assigned for each PTZ command)	
	• ON : LIGHT ON	• SET : SET PRESET
	• OFF : LIGHT OFF	• CLEAR : CLEAR PRESET
	• OPEN : IRIS OPEN	• GOTO : GOTO PRESET
	• CLOSE : IRIS CLOSE	• AUTO : AUTO SCAN
	• NEAR : FOCUS NEAR	• F1 : USER 1
	• FAR : FOCUS FAR	• F2 : USER 2
• WIDE : ZOOM IN	• F3 : USER 3	
• TELE : ZOOM OUT	• F4 : USER 4	
⑤ Record / Playback	REC	Emergency Record at continuous, 60ips, SUPER FINE size
	STOP	Stop of Emergency Record and return to Schedule Record from Emergency Record. Playback stop.
	PLAY	Playback of recorded data on HDD
	SEARCH	Search recorded data on HDD
⑥ SETUP	MENU	Set up for SYSTEM MENU or Use to exit the menu
	ENTER	Selects each menu option
	NEXT	Move to next step
	▲▼▶◀	Navigate in the menu
	+ -	Reduce or increase the option value in the menu

Name	Function	
⑦ LIVE View Control	PTZ	On/Off for PAN/TILT/ZOOM control mode Press this button first to control PTZ camera connected to DVR unit via RS-485
	ZOOM	Zooming an image
	FRZ	Freezing an Image
	MODE	Switch to split display MODE button changes screen-division from (to) full screen to (from) 16-split screen.
	PIP	Display in PIP (Picture in Picture) mode
	SEQ	Auto camera image sequencing in full screen mode
	K.LOCK	Lock the key function. To unlock, press longer time (for several seconds) and then input the password.
	Q. Play (Quick Play)	Press Q. Play button while you see live display, and playback starts from the end of data in reverse direction
⑧ Jog Shuttle Control	J/SHUTTLE	Pressing Jog Shuttle button (Ready for use Jog/Shuttle) : In playback mode, pressing J. SHUTTLE button make images frozen.
		RUN LED on : While you operate Jog or Shuttle
		ACTIVE LED on : When J. SHUTTLE button is pressed
⑨ Jog Shuttle	Very easy and convenient search : Press J. Shuttle button, and images in playback pause, and then Jog and Shuttle makes it very easy and convenient to search, forward or backward, fast and slow, as user want.	
⑩ CD-RW	Data Back-up and Firmware Upgrade using built-in CD writer	

2-2. REAR

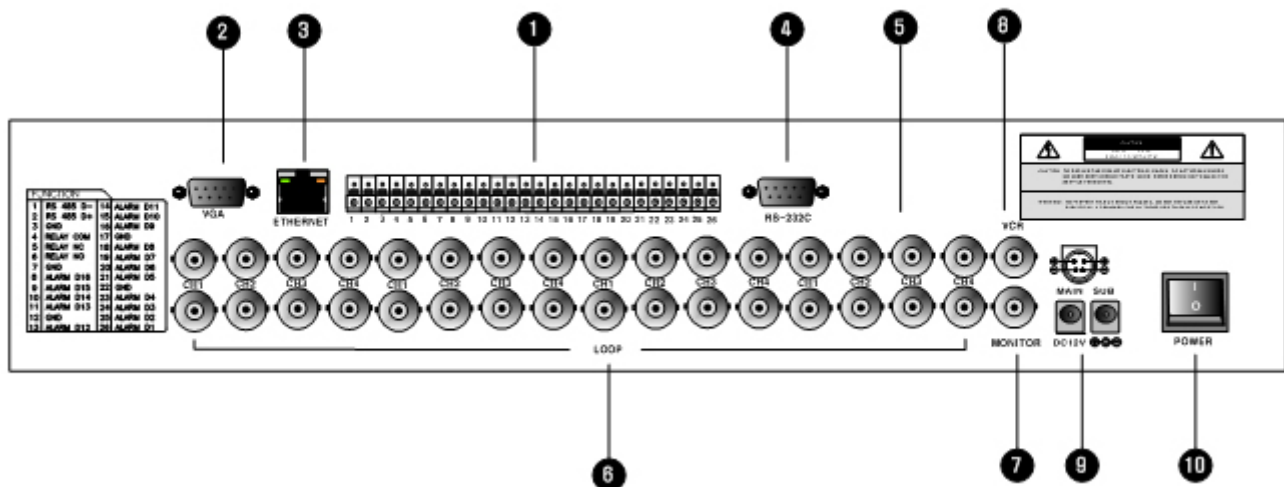

	Name	Function
1	RS 485	Connection with PTZ Camera or other external device using RS 485 interface (Pin No.1 & 2)
	RELAY Output	Relay out terminal (Pin No.3, 4 and 5)
	SENSOR Input	Sensor input terminal(Pin No.6 : Ground, Pin No. from 7 to 10 : Sensor input)
2	VGA	Connection to VGA Monitor (CRT type or TFT LCD monitor) Just in case you purchased DVR with VGA option board fixed on the main board of DVR, you can connect VGA Monitor to DVR unit.
3	ETHERNET	Connection to ETHERNET device
4	RS-232C	Connection to external device as PC using RS-232C to control the DVR
5	CAMERA Input	Connection with camera
6	LOOP Output	Camera loop out
7	MONITOR Output	Connection with Composite Monitor
8	VCR Output	Connection with VCR for analog backup
9	DC Power	DC 12V 5A Adaptor (Refer to the Instruction for adapter by HDDs capacity)
10	POWER SWITCH	Power ON/OFF switch for adapters

CHAP.3 Installation

3-1. Installation Configuration

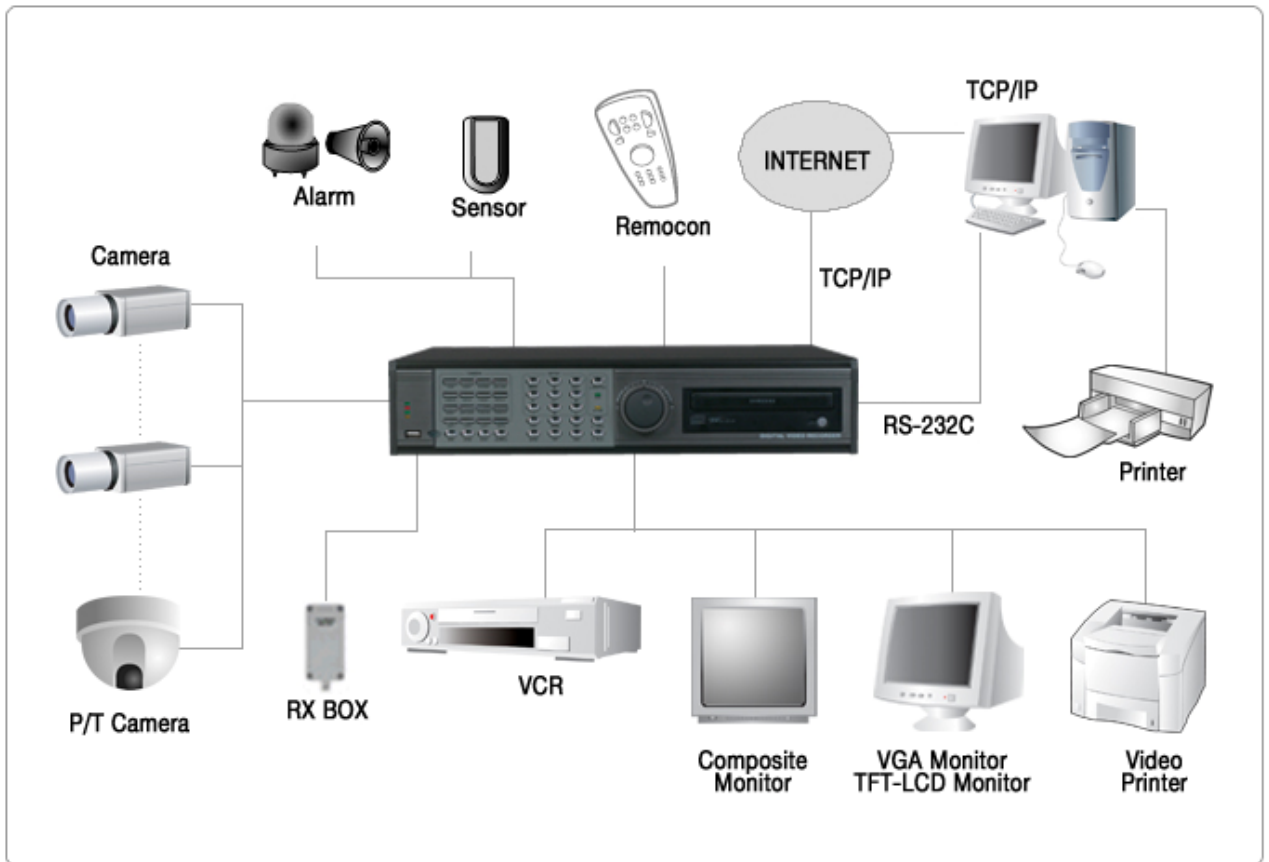

3-2. Detailed Installation

1) Rack mount

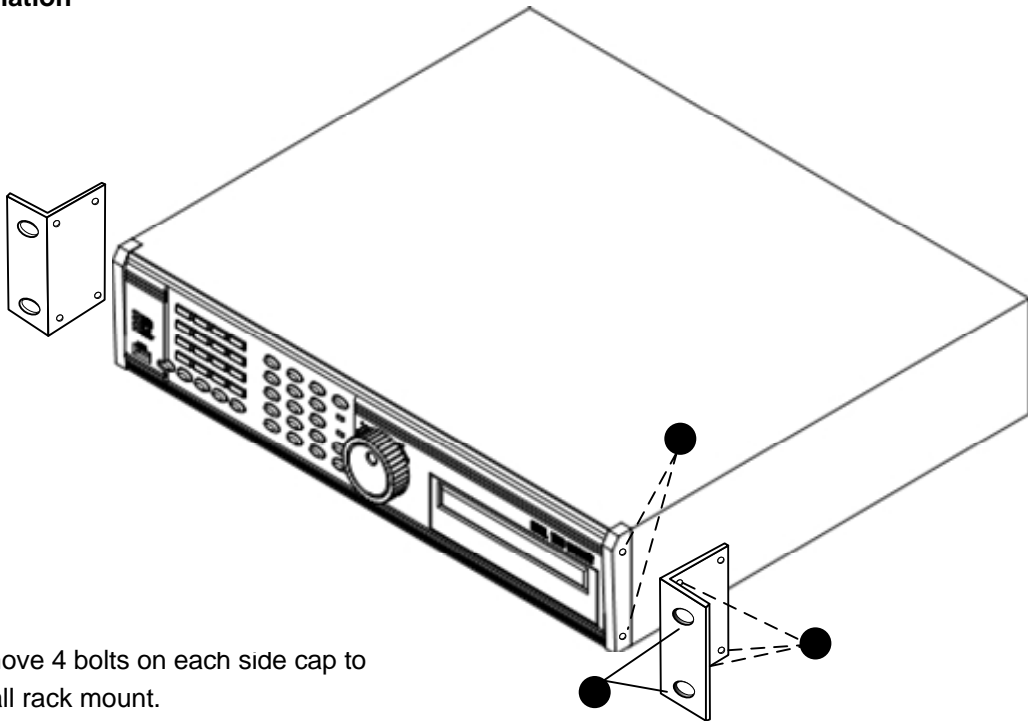

1. Remove 4 bolts on each side cap to install rack mount.
2. Attach rack mount bracket to DVR.
3. Attach DVR with rack mount bracket to 19" rack.

2) HDD

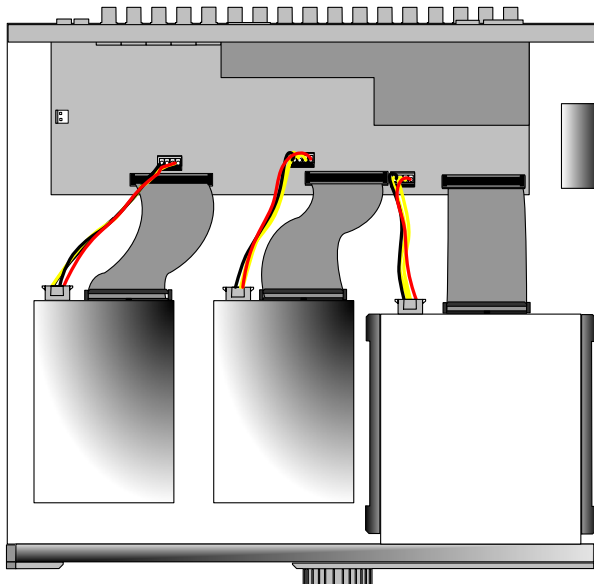

1. Connect Main Board and HDD1 using IDE cable and HDD power cable.
2. The jumper setting of HDD1 should be on Master if you install only one HDD.
3. The jumper setting of HDD1 should be on Master and HDD2 should be on Slave if you install two HDDs.(Refer to the above figure)
4. Stick the HDD absorber (included in package) on the bottom of case and then install the HDD on top of them by using the bolts (included in package).
5. Screws must be inserted from outside of the case bottom.

3) Camera

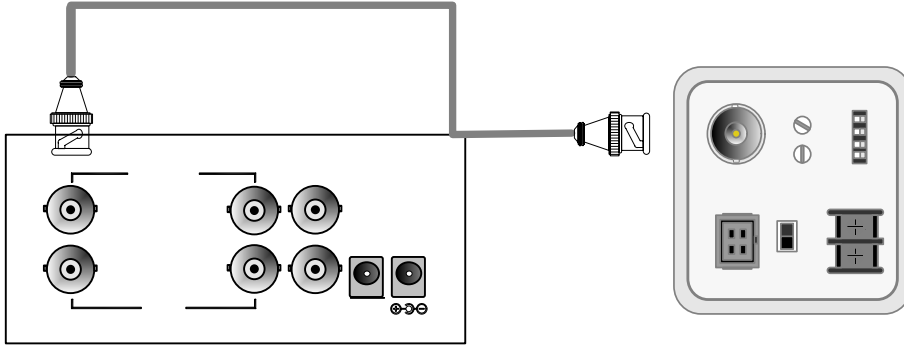

Connect cameras to the camera input on rear panel of DVR marked CAMERA IN.

4) Monitor

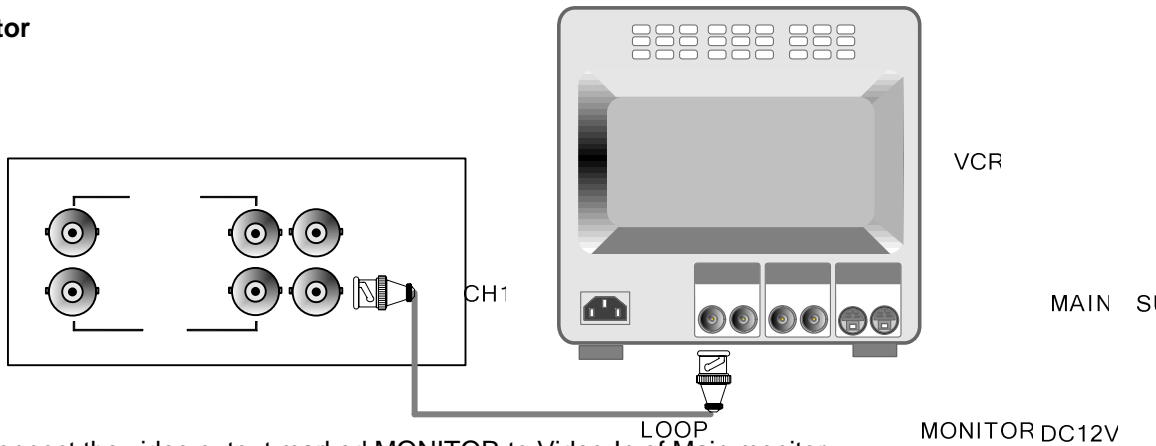

Connect the video output marked MONITOR to Video-In of Main monitor.

5) Power

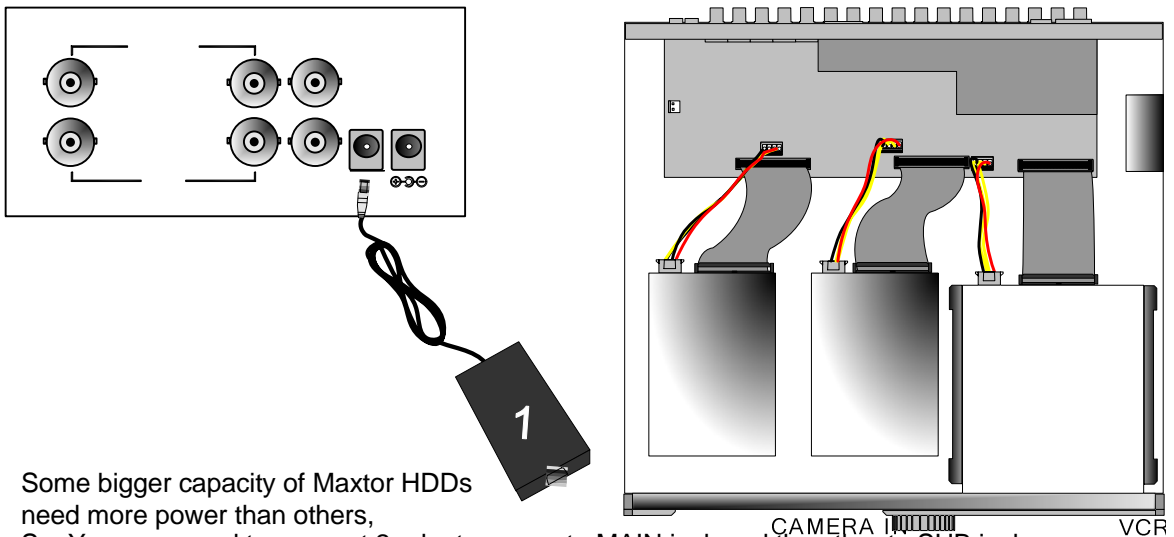

Some bigger capacity of Maxtor HDDs need more power than others,

So, You may need to connect 2 adapters, one to MAIN jack and the other to SUB jack.

If you install 2 IBM Hitachi HDDs with any capacity, just connect one adapter to MAIN jack.

For details, refer to Adapter Instruction included in the package.



Before you turn on the Power switch, be sure all necessary devices such as Power adaptor, cameras and Monitor are connected properly to DVR!

LOOP

6) VCR, VIDEO PRINTER

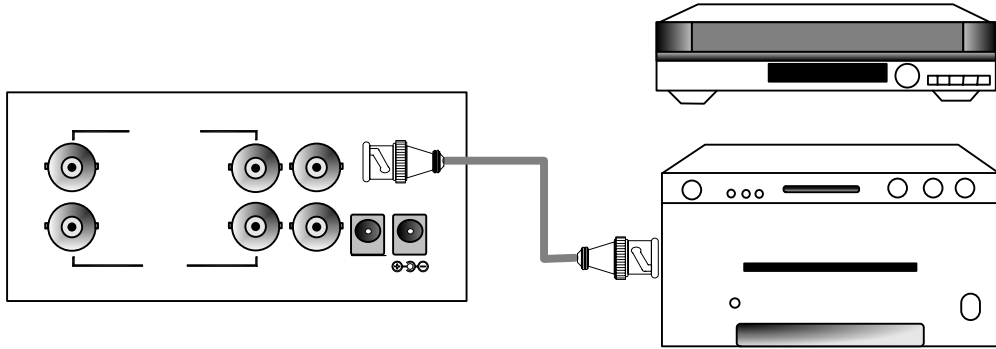

Connect VCR or VIDEO Printer to VCR out on the rear panel of DVR.

7) Other External Device

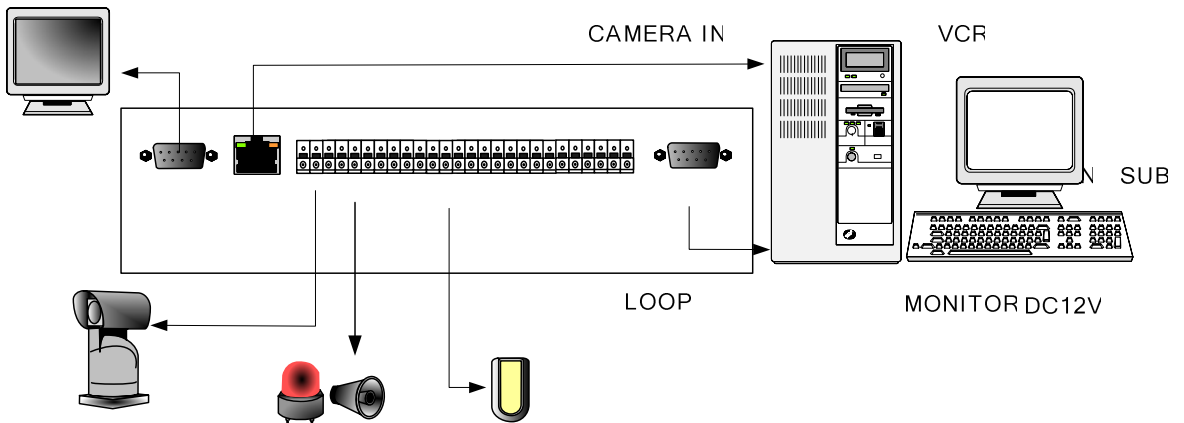

RS-232C : Control DVR through RS-232C port by using PC.

RS-485 : Control external device like PTZ Camera (Pin No.1 & No.2 at Terminal Block).

RELAY Output : Relay Output (Pin No.3 ~No.5 at Terminal Block).

SENSOR Input : SENSOR Input (Alarm connection)(Pin No.6 ~ No.10).

ETHERNET : Connection to LAN, WAN, Internet.

VGA : Connection to a VGA monitor(CRT,TFT LCD) if optional VGA board is fixed on the main board as shown in the following figure.

Resolution set by manufacturer is 800x600 60 Hz, and user can set resolution in MONITOR SETUP / VGA SETUP / VGA RESOLUTION.

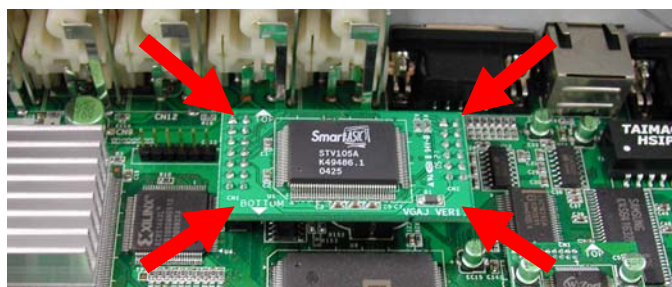

VGA
MONITOR

8) Connector Pin Assignment

No		Description	NO		Description
1	DCD	Data Carrier Detect	6	DSR	Data Set Ready
2	RxD	Receive data	7	RTS	RS232C: Rx/Tx data
3	TxD	Transmit data	8	CTS	RS232C: Rx/Tx data
4	DTR	Data Terminal data	9		
5	GND	Signal Ground			

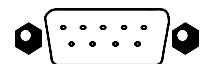

9) RS-232C ASCII-code

Following ASCII-Codes(Hexa-Code) are for programmers who want to control DVR unit via the RS232C Port using keyboard of PC.

All ASCII-Code is 1 Byte.

REC	'R'	DOWN	'J'	PTZ	'T'	KLOCK	'C'	CH6	'6'	CH13	'#'
STOP	'S'	LEFT	'H'	ZOOM	'Z'	QPLAY	'Y'	CH7	'7'	CH14	'\$'
PLAY	'P'	RIGHT	'K'	FRZ	'F'	CH1	'1'	CH8	'8'	CH15	'%'
Pause	'A'	NEXT	'N'	MODE	'D'	CH2	'2'	CH9	'9'	CH16	'^'
SERCH	'E'	ENTER	0x0d	PIP	'I'	CH3	'3'	CH10	'0'		
MENU	'M'	-	'<'	SEQ	'Q'	CH4	'4'	CH11	'!'		
UP	'U'	+	'>'	J.SHU	'L'	CH5	'5'	CH12	'@'		

Jog / Shuttle

Please input 'L' command to activate J/SHUTTLE function using keyboard of PC.

Shuttle Right 10 degree	"&<1"[enter]	Shuttle Left 10 degree	"&>1"[enter]
Shuttle Right 20 degree	"&<2"[enter]	Shuttle Left 20 degree	"&>2"[enter]
Shuttle Right 30 degree	"&<3"[enter]	Shuttle Left 30 degree	"&>3"[enter]
Shuttle Right 40 degree	"&<4"[enter]	Shuttle Left 40 degree	"&>4"[enter]
Shuttle Right 50 degree	"&<5"[enter]	Shuttle Left 50 degree	"&>5"[enter]
Shuttle Right 60 degree	"&<6"[enter]	Shuttle Left 60 degree	"&>6"[enter]
Shuttle Right 70 degree	"&<7"[enter]	Shuttle Left 70 degree	"&>7"[enter]
		Shuttle Left 80 degree	"&>8"[enter]
Jog Minus	"&-"[enter]	Jog Plus	"&+ "[enter]

Shuttle : After inputting a command once, it will keep performing the command until next command.

Jog : It makes the stage staying after one time operation by command input like Button operation.

4-1. System Log-In

- 1) To enter into the setup menu, press the [MENU] button.
- 2) Enter password with channel number button from No.1 to No.10 on the front of the DVR unit. (Maximum of 8 digits are available)
- 3) After inputting the password, press the [ENTER] button.



Administrator :

If the password entered matches previously set password, " LOGIN ADMIN" message appears and you can enter into SYSTEM SETUP.

If the password entered does not match previously set password, the DVR unit goes back to live display mode.

Factory default password is blank. For log-in, just press [MENU] button and then [ENTER] button.

- Factory default password
- ADMIN : (Blank)
- MANAGER : ' 1 '
- USER 1~USER8 : ' 2 ' ~ ' 9 '

※ We recommend configuring a unique password as per the procedure in SYSTEM MENU - CONFIGURATION - PASSWORD SETUP.

※ For security reasons, be sure to make note of your own password.

4-2. Factory Default

Before first operation, you must set Time/Date, set FACTORY DEFAULT, and then clear HDD, even though it is brand new one. It is to make DVMR system and HDD ready for proper operation. Starting recording without FACTORY DEFAULT setting and HDD clear will cause malfunction.

1. HDD CLEAR

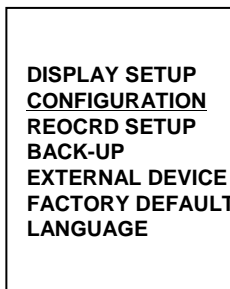

Refer to page 22.

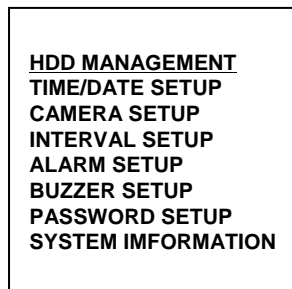

2. FACTORY DEFAULT

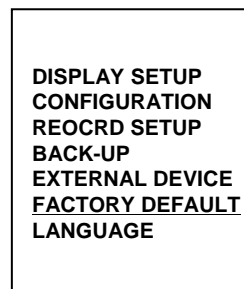

Refer to page 31.

4-3. Display Configuration

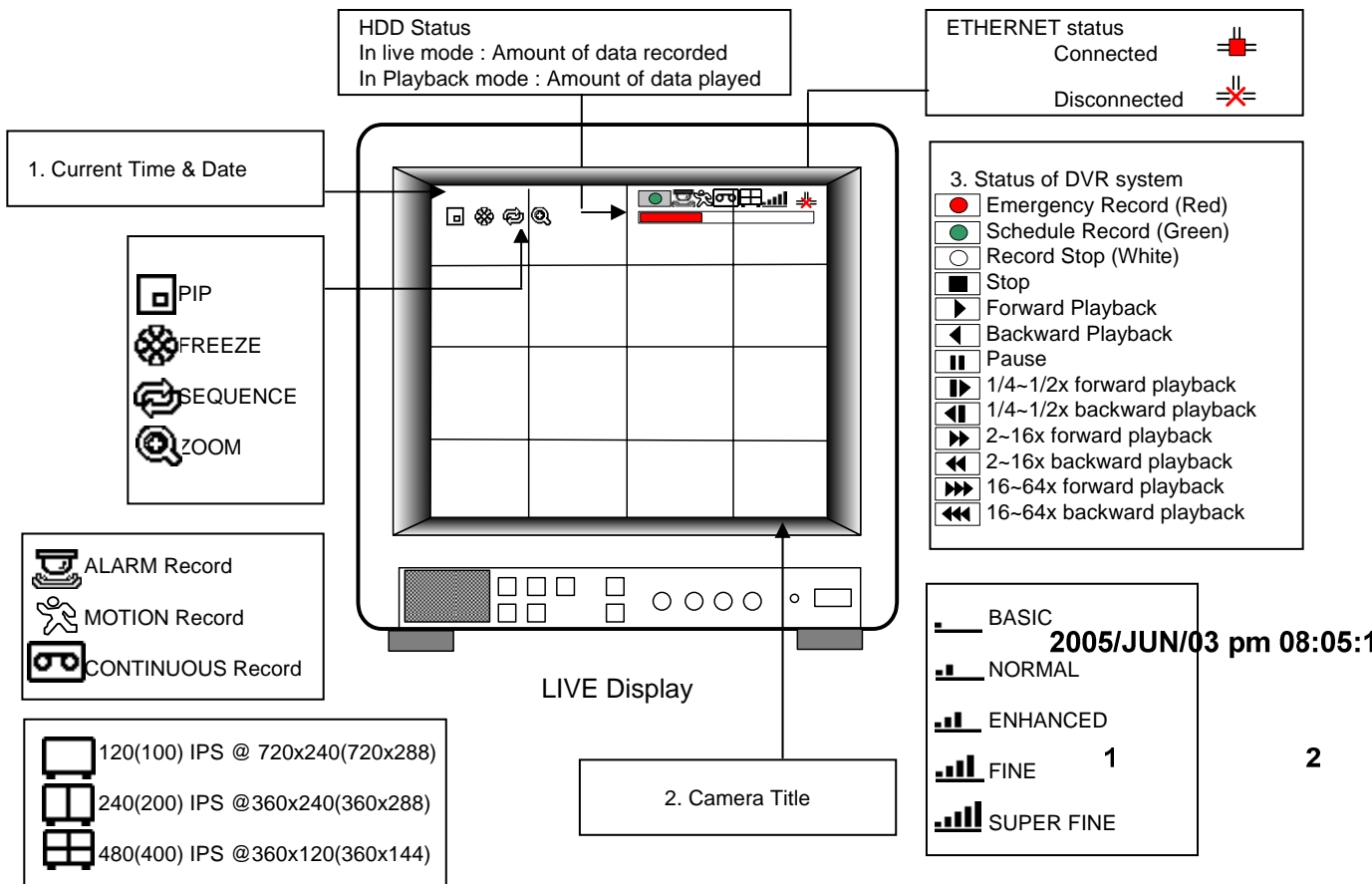

4-4. Live View Setup

1) Full / Multiple View

Switch to multi-screen display by pressing [MODE]. For full image display, just press the channel button which you want or continue to press [MODE] button until you see full screen. 10

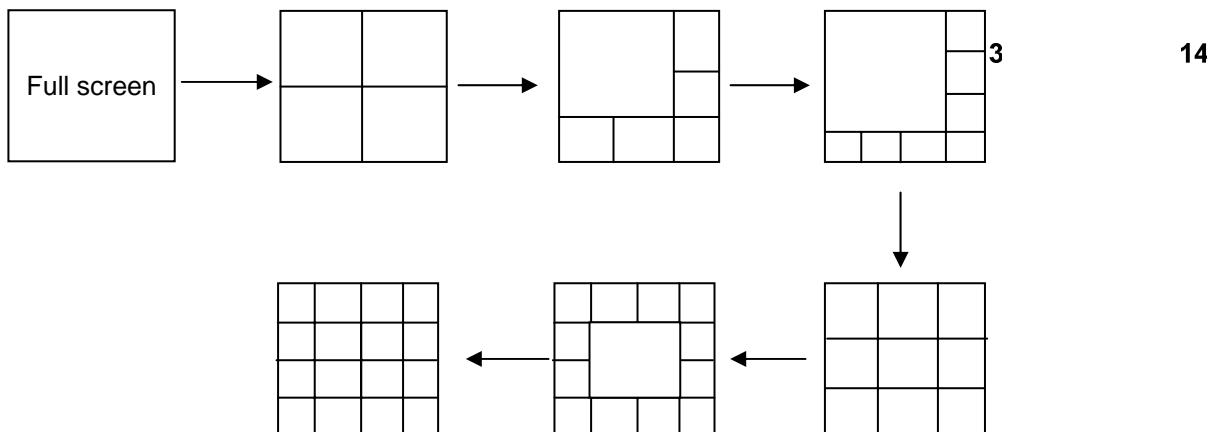

Multiple screen changes

2) View in Sequence

Press [SEQ] button. It automatically displays full screen images in sequence.

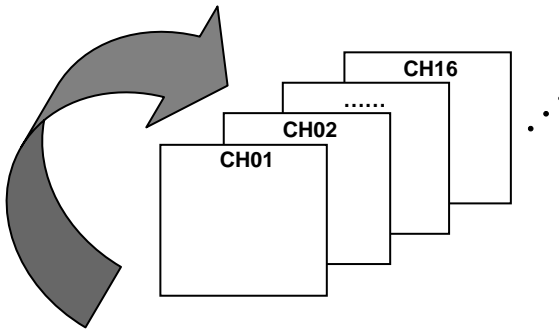

3) Picture in Picture(PIP View)

When it is in full screen display mode, you can see other camera in a small window by pressing [PIP]. The other camera in small window is rotating in sequence to next number of camera and you can set the rotating time interval as per the procedure in SYSTEM MENU-CONFIGURATION-INTERVAL SETUP.

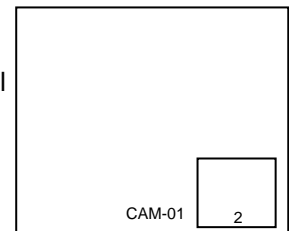

4) Freeze View

Full display mode : If you press the [FRZ] button, the FRZ icon will be activated on the screen and "F" character will be shown beside camera title, and live image will be frozen.

Split display mode : If you press the [FRZ] button, the FRZ icon will be activated on the screen. press the channel button which you want to freeze.
To release frozen image, press channel number of frozen image again and press [FRZ] button to exit FRZ mode.

5) Zoom View

In full screen, press the [ZOOM] button and move the Selection Frame using J.SHUTTLE or Direction keys to the area which you want to enlarge. And then press the [ENTER] button for 2-times enlarged picture. To exit Zoom mode, just press [ZOOM] button again.

Horizontal Movement : J.SHUTTLE



Vertical Movement : Hold [UP or DOWN] button and turn J/SHUTTLE

4-5. Record



Recording mode set before delivery by manufacturer (Default recording mode) is Schedule Recording. In this default recording mode, it records 24 hours/day continuously in weekday and on the weekend.

Once you press the [REC] button while you see live view, the record type is changed to Emergency Record mode.

- Emergency Record : at full resolution/in best quality
Record type : CONTINUOUS, SUPER FINE quality,
120 (100) ips at 720X240 (720x288)
- Schedule Record
Record and stop as set (time interval and record type) in RECORD-SCHEDULE SETUP menu.
- Stop Record
Recording stopped as set in RECORD-SCHEDULE SETUP menu.

-  Emergency Record [RED]
-  Schedule Record [GREEN]
-  Stop Record [WHITE]

On the screen

- Emergency Record
: Red Record Icon () and Record LED is lit
- Schedule Record
: Green Record Icon () and Record LED is lit
- Record Stop
: White Icon () and Record LED is off
- Motion Record, Alarm Record, Alarm+Motion Record
: Record standby LED blinks
: Record LED is lit
- ※ While in Emergency Record mode, press [STOP], [PLAY], [MENU], or [SEARCH] button to exit from Emergency Recording mode and return to Schedule Record mode.
- ※ For details, refer to the SYSTEM MENU – RECORD SETUP (Page 27)

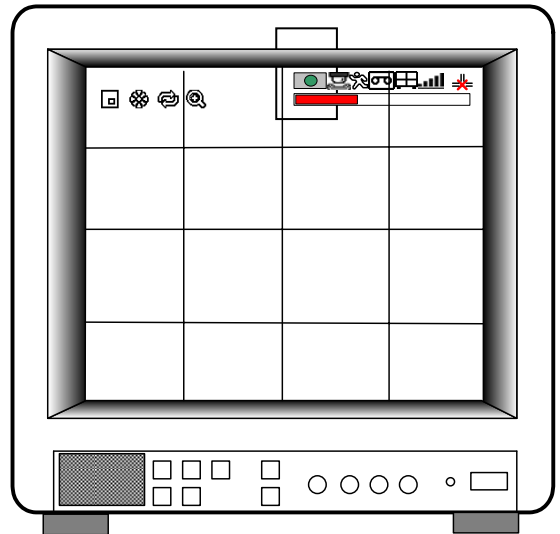

- This DVR unit does not record in following conditions ;

- ※ While entered in the Menu.
- ※ No camera is connected
- ※ Overwriting is off in the Record Setup menu.

4-6. Playback

On record mode or stop mode, press [PLAY] button to play the recorded data in 1x speed.

For backward playback, press [PLAY] button again.

Use Jog/Shuttle to pause and control playback speed. To stop playback, press the [STOP] button.

Using Jog/Shuttle

press the [J.SHUTTLE] button in playback mode. The [ACTIVE] LED will be lit, and Jog/Shuttle is ready for use. The [RUN] LED will blink whenever you operate the Jog/Shuttle.

For forward playback, turn the Shuttle right and turn Shuttle left for backward playback.

Turn Jog using your index figure to see picture by picture in forward or backward direction.

Operation of Shuttle is as follows.

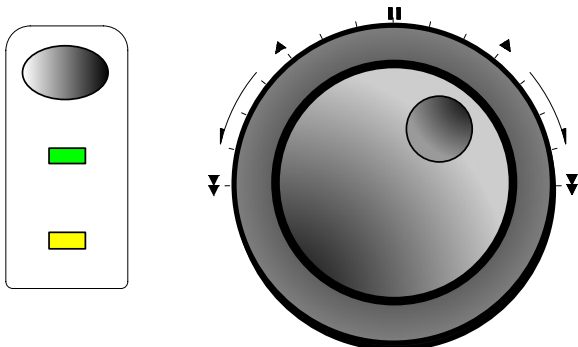

- 1/4 x : 4 times slower than normal playback speed
- 1/2 x : 2 times slower than normal playback speed
- 1 x : Normal playback speed
- 2 x : 2 times faster than normal playback speed
- 4 x : 4 times faster than normal playback speed
- 16 x : 16 times faster than normal playback speed
- 64 x : 64 times faster than normal playback speed

If you want to keep the playback speed you selected using Shuttle, just hold the shuttle at that location for a few seconds, and playback in speed you selected continues until you rotate Shuttle again.

4-7. Search

Press [SEARCH] button, and 3 different methods for searching recorded data are available as shown in following SEARCH window. For selecting searching method, use direction key or Jog/Shuttle. After selecting each search method, press [ENTER] button for playback. exit, press [MENU] button.

1) SEARCH BAR

Search by percentage of total recorded data. It starts from image corresponding to set % of data on the search bar.

2) TIME/DATE

Search by time & date. Playback starts from the time & date selected.

3) EVENT LIST

Search by event list (Motion, Alarm, Video Loss).

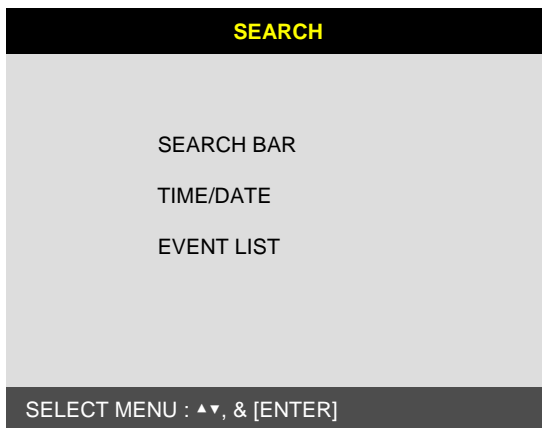

SEARCH page

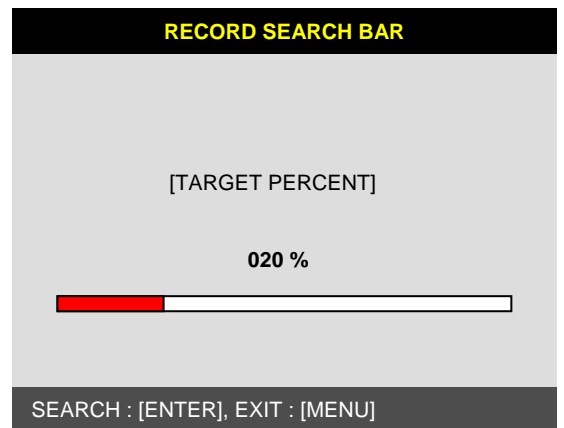

SEARCH BAR page



TIME/DATE page

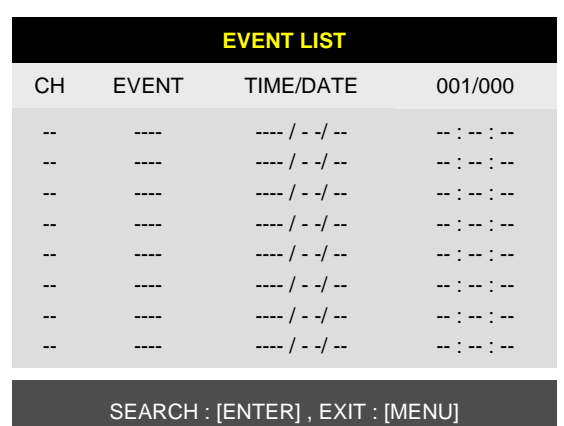

EVENT LIST page

4-8. PAN/TILT/ZOOM Camera Operation

Press [PTZ] button first for PTZ control mode. Numeric buttons from 1 to 16 and direction buttons are assigned for each PTZ command, and user can control PTZ camera connected to DVR unit by pressing any one of those 20 buttons, one after the other, as needed, and it is just like control by separate PTZ controller.

Button	PTZ command	Button	PTZ command
1/ON	LIGHT ON	10/CLEAR	PRESET CLEAR
2/OFF	LIGHT OFF	11/GOTO	PRESET GOTO
3/OPEN	IRIS OPEN	12/AUTO	PRESET AUTO
4/CLOSE	IRIS CLOSE	13/F1 ~ 16/F4	FUNCTION
5/NEAR	FOCUS NEAR	UP BUTTON	TILT UP
6/FAR	FOCUS FAR	DOWN BUTTON	TILT DOWN
7/WIDE	ZOOM IN	LEFT BUTTON	PAN LEFT
8/TELE	ZOOM OUT	RIGHT BUTTON	PAN RIGHT
9/SET	PRESET SET		

4-9. Data Back-Up

Enter into SYSTEM MENU-BACKUP-CDR SETUP.

- 1) Insert empty CD-R media into CD writer and select the start time & date from which you want to back up.
 - ⊗ The START & END time / date in HDD sub-menu only shows start and end of recording. This is not selectable and editable.
 - ⊗ 700MB on CD-R sub-menu represent size of CD-R media inserted.
- 2) To set start time of back-up and back-up data size, press the [ENTER] button first on [START] or [SIZE] sub-menu and adjust using [+] or [-] button and move using [LEFT] and [RIGHT] button for next change. After setting the time & date and back-up data size, press the [ENTER] button again to exit.
 - ⊗ End of back-up time will be calculated automatically as per start time & date and the back-up data size you set.
 - ⊗ User can select the back-up data size (size of back-up data from start of back-up) on [SIZE] item but END of back-up time is automatically determined by DVR system.
- 3) Press [ENTER] button on BURN sub-menu. DVR system starts burning CD.
- 4) When burning is completed, CD-R media will come out automatically. In the next CD back-up, start time of CD-R shall be the end time of previous CD-back-up, and you can back-up from that for continuous data back-up. If you need another backup, repeat the above procedure. To stop backup, press the [MENU] button.
 - ⊗ During burning CD, it's impossible to cancel burning process.
- 5) User can verify the back-up CD on PC with BACK-UP CD PLAYER (Included in Package).

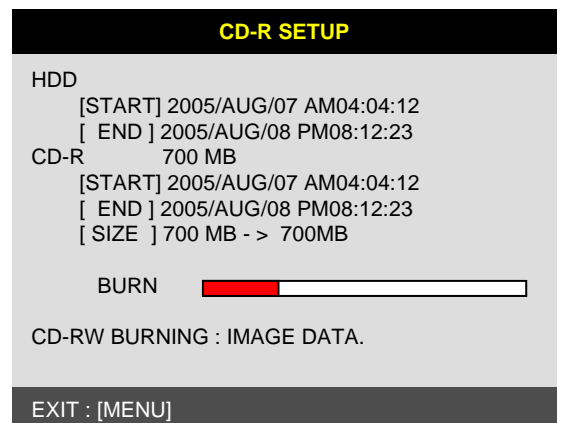
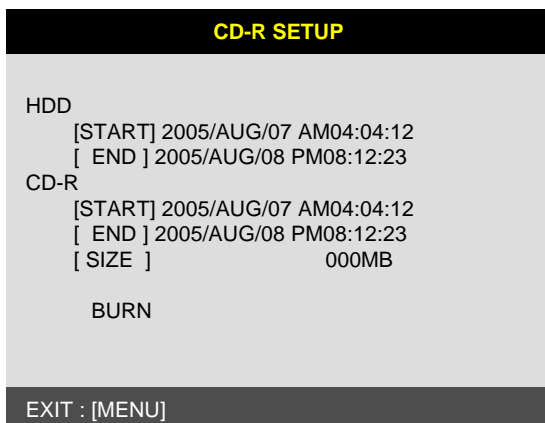

CHAP. 5 Set Up

5-1. Entering into the Menu

Enter into SYSTEM MENU by pressing [MENU] button.

Button	Function
MENU	Enter into SYSTEM MENU, Move to previous menu, ESC
ENTER	Selection key, Move to sub-menu, change status (ON or OFF)
NEXT	Move to next page
UP	Move to upper side
DOWN	Move down side
LEFT	Move to the left
RIGHT	Move to the right
MINUS [-]	Decrease the option value
PLUS [+]	Increase the option value
Jog Shuttle	Jog left turning : Move backward to next image / Decrease value Jog right turning : Move forward to next image / Increase value
	Shuttle left turning : Decrease playback speed / Decrease value Shuttle right turning : Increase playback speed / Increase value

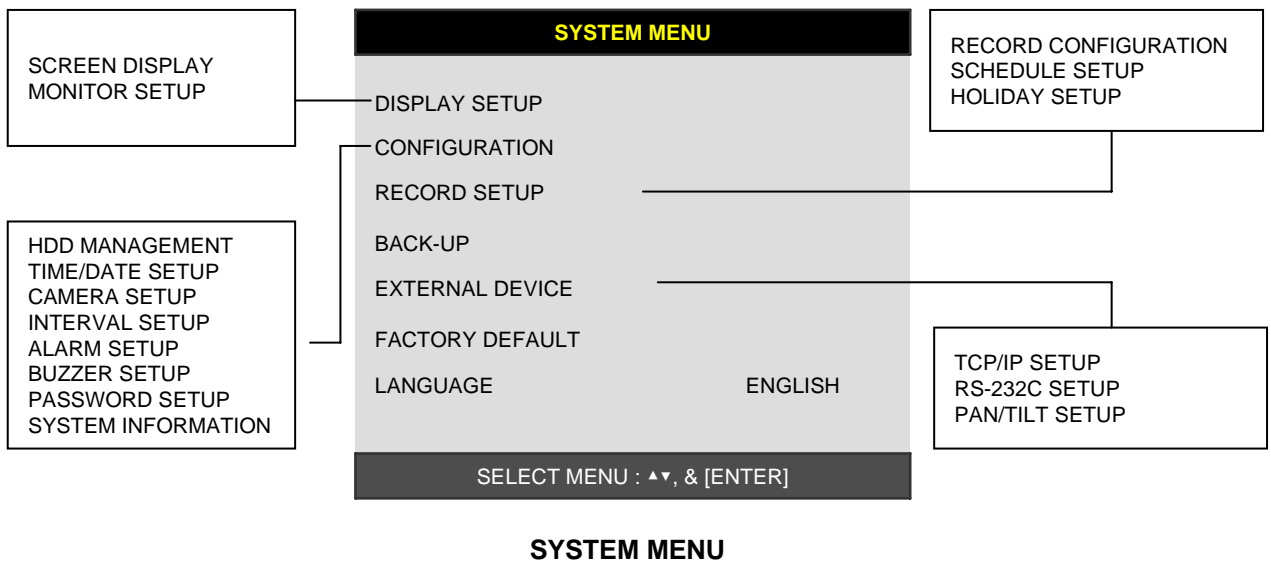

5-2. DISPLAY SETUP

Setting up parameters for monitor and display on screen.
Enter into SYSTEM MENU-DIPLAY SETUP.

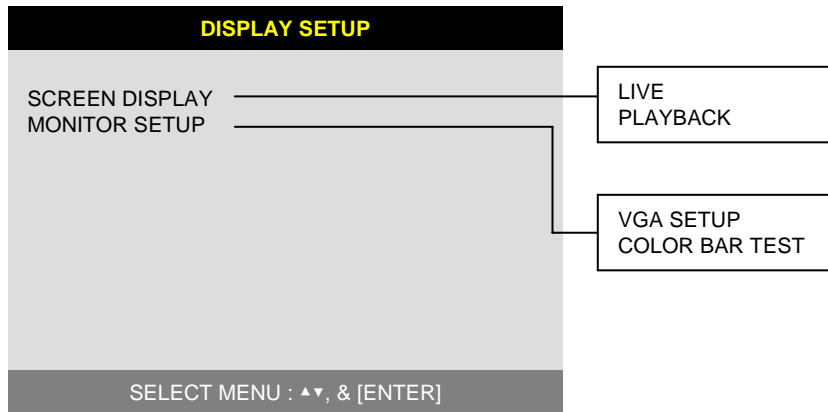

1) SCREEN DISPLAY

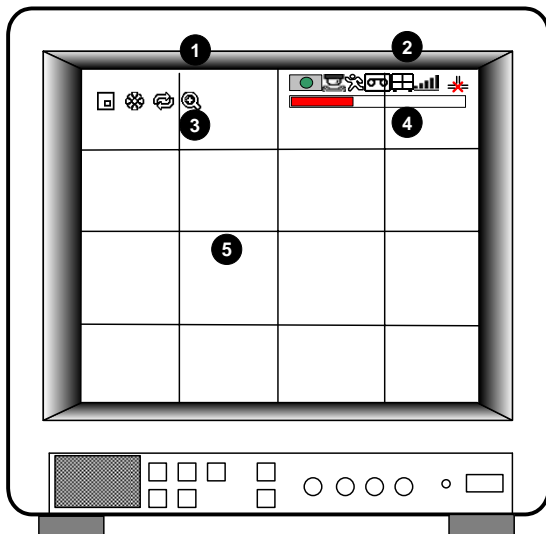

Setting up the screen display in LIVE mode and PLAYBACK mode.

Select the sub-menu which you would like to set using direction buttons and then change ON/OFF with [ENTER] button.

1. TIME/DATE : Display time & date
2. DVR STATUS : Display system setting status
3. ICON DISPLAY : Display function setting status
4. REC/PLAY BAR : Display record / playback status
5. CAMERA TITLE : Display camera title

2) MONITOR SETUP

VGA SETUP : VGA option card enables to connect TFT LCD monitor or CRT type PC monitor to DVR unit. To connect TFT LCD monitor or CRT type PC monitor to DVR unit, select resolution as follows using [+] or [-] button. After setting the below option, press [ENTER] button then the DVR unit will set VGA resolution automatically. VGA option card supports following resolution, and choose best resolution that match TFT LCD monitor or CRT type PC monitor to be connected to DVR unit.

- 640X480 / 60Hz
- 640X480 / 75Hz
- ※ NOTICE :** In the booting process,
- 800x600 / 60Hz
- 800X600 / 75Hz
- DVR unit with VGA option
- 1024X768 / 60Hz
- 1024X768 / 75Hz
- card takes some seconds
- more to set parameters.

COLOR BAR TEST : Adjust color tone of monitor.

5-3. CONFIGURATION

Various parameters for system can be set in CONFIGURATION menu.
Enter into SYSTEM MENU-CONFIGURATION and press the [ENTER] button.

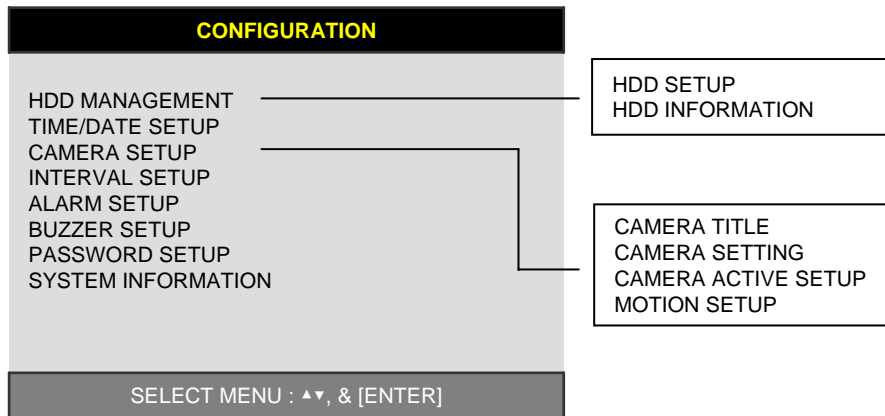

1) HDD MANAGEMENT

Enter into SYSTEM MENU-CONFIGURATION-HDD MANAGEMENT and press the [ENTER] button.

(1) HDD SETUP

This page includes information about start and end of recording, location of recorded data, or location of last playback on HDD. In addition, users can delete all the data on HDD.

HDD SETUP		
STATUS	HDD	DATE/TIME
BEGIN	MASTER	2005/04/08 12:12:05
RECORD	MASTER	2005/04/09 15:09:58
PLAY	MASTER	2005/04/08 19:44:31
HDD STATUS		NORMAL
HDD CLEAR		IN USE →

HDD CLEAR [ENTER], EXIT [MENU]

On the [HDD CLEAR] sub-menu, press the [ENTER] button to delete all image data on HDD. The system will ask password for verification. After you clear all data on HDD, status of HDD CLEAR changes from IN USE to EMPTY.
※ When you clear HDD, event list is deleted, too.

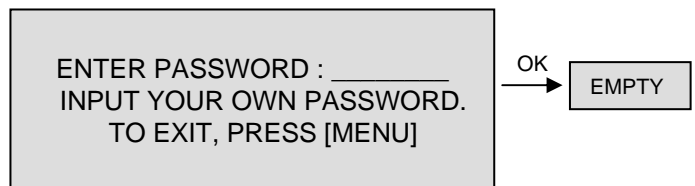

If you selected OVERWRITE in Record Setup, the HDD STATUS presented as OVERWRITE.

(2) HDD INFORMATION

This menu will show the physical information of HDD in DVR.

HDD INFORMATION	
[MASTER]	
MODEL	: Maxtor 6Y080L0
SPEED	: PIO-4
SIZE	: 76GB
START	: 2005/04/08 12:08:56
END	: 2005/04/08 12:08:56
[SLAVE]	
MODEL	: AT5520026DT
SPEED	: 240/120nsec
SIZE	: 80GB
START	: 2005/04/08 12:08:56
END	: 2005/04/08 12:08:56

TO EXIT, PRESS [MENU]

2) TIME/DATE SETUP

Set time and date of DVR system which is very important for search with time and date of the event. Time and date set by manufacturer is different from local time of user, and user must set time and date exactly in the first operation. Set time & date using direction buttons and [-][+] button or Jog shuttle

TIME/DATE SETUP

YEAR	
MONTH	2005 / JUN /11
DAY	
HOUR	PM14:06:45
MINUTE	
SECOND	

SELECT : ▲▼, CHANE VALUE : - +

3) CAMERA SETUP

CAMERA SETUP

CAMERA TITLE
CAMERA SETUP
CAMERA ACTIVE SETUP
MOTION SETUP

SELECT MENU : ▲▼, & [ENTER]

CAMERA TITLE SETUP

0123456789 .ABCDEFGHIJKLMNO
 RSTUVWXYZ !#-[]*+ ,./ :<=>?@▶◀

CAMERA01	CAM -1
CAMERA02	CAM -2
CAMERA03	CAM -3
CAMERA04	CAM -4
CAMERA05	CAM -5
CAMERA06	CAM -6
CAMERA07	CAM -7
CAMERA08	CAM -8

[ENTER] SELECT MODE
[▲/▼] select CAMERA

(1) TITLE : Input Title of each camera. Move to channel you want to change using [LEFT] or [RIGHT] direction button and then change the title using [-] [+] button. When modification is finished, press the [ENTER] button. To exit to previous menu, press the [MENU] button.

(2) COLOR : Adjust image color
 Move to each element using [UP][DOWN] button and adjust using [-] [+] button or Jog shuttle.

CHANNEL : Select camera
 BRIGHTNESS : Adjust image brightness (-32~ 31)
 CONTRAST : Adjust color contrast (-32 ~ 31)
 SATURATION : Adjust color saturation (-32 ~ 31)
 HUE : Adjust color hue (-32 ~ 31)

CAMERA COLOR SETUP

CHANNEL	1
BRIGHTNESS	+0
CONTRAST	+0
SATURATION	+0
HUE	+0

SELECT : ▲▼, CHANE VALUE : + -

CAMERA ACTIVE SETUP			
CH	STATUS	LIVE	REC
01	ACTIVE	ON	ON
02	ACTIVE	ON	ON
03	LOSS	OFF	OFF
04	ACTIVE	ON	OFF
05	ACTIVE	ON	ON
06	ACTIVE	ON	ON
07	ACTIVE	ON	ON
08	ACTIVE	ON	ON

SELECT : ▲▼◀▶, & [ENTER]

MOTION CONFIGURATION	
CHANNEL	01
SENSITIVITY GRADE	01
MOTION DISPLAY TYPE	OFF
RECORD DURATION	05 SEC

SELECT ▲▼, CHANGE VALUE : + -

(3) CAMERA ACTIVE SETUP : With direction button, move to option to be changed, and press [ENTER] button to select [ON/OFF]. If it is set at LIVE [OFF] and REC [ON], DVR system records, but does not show live image of set channel.

- STATUS : Shows if image from a specific channel is coming for live display and recording. In normal camera condition, it is ACTIVE, but LOSS is displayed when the cable is disconnected or camera is not working.
- LIVE : Decides whether to show LIVE screen image or not.
- REC : Decides whether to record relevant channel or not.

(4) MOTION SETUP: You can set sensitive of motion detection in 4 steps, detection window number, motion detection area and others in relation to motion recording in this menu.

(4)-1. MOTION SETUP

- SENSITIVITY GRADE : Adjusts motion detection sensitivity. (LOW, MEDIUM, HIGH, VERY HIGH)
- MOTION DISPLAY TYPE : Showing cells with motion detected differently from cells with no motion .
- RECORD DURATION : Whenever motion is detected and it is set at Motion Recording mode, DVR system records for RECORD DURATION from time motion is detected. (1sec. ~ 99 sec.) (Default duration : 5 sec.)

(4)-2. MOTION MASK SETUP: Set motion detection area. Direction button is for moving and [ENTER] button is for selection, and [MODE] button is for changing mode of MASK SETUP.

- CELL : Move to the location which you want to detect and then press the [ENTER] button. Highlighted cell area means motion detection area.
- ALL ON : Set all cells as detection area. Use [ENTER] button to set.
- ALL OFF : Set all cells as no-detection area. Use [ENTER] button to set.
- BLOCK ON : Select detection area by block. Use [MODE] button and press [ENTER] button to set ON.
- BLOCK OFF : Select un-detection area by block. Use [MODE] button and press [ENTER] button to set ON.

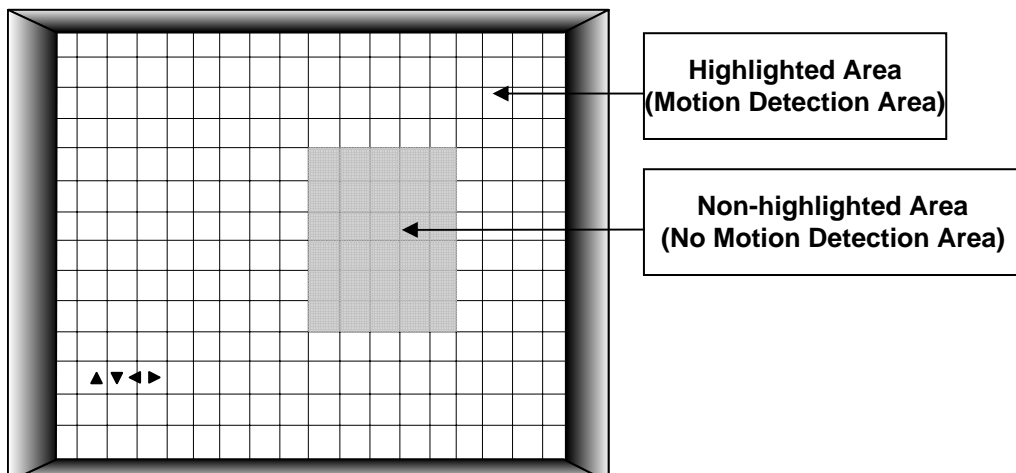

4) INTERVAL SETUP

Set the switching time interval for SEQ or PIP function.(1 sec. ~ 99 sec.)

FULL SCREEN : set the sequencing switch time interval in live full screen.

PIP SCREEN : set the sequencing switch time interval of PIP window.

EVENT UPDATE TIME : Set the minimum time interval of event to be listed in EVENT LIST.
 If EVENT UPDATE TIME is set at 20 sec, only following event happened 20 sec or more than 20 sec later previous event shall be listed in EVENT LIST.

INTERVAL SETUP	
SWICHING INTERVAL	
FULL SCREEN	: 01 SEC
PIP SCREEN	: 01 SEC
EVENT RECORD	
EVENT UPDATE TIME	: 01 SEC
SELECT ▲▼◀▶, CHANGE VALUE : + -	

5) ALARM SETUP

Set type of alarm sensors connected to DVR unit.
 N.O represents Normal Open type and N.C Normal Close type.

ALARM SETUP	
CHANNEL	CH1
ALARM INPUT	N.O
DURATION	005
N.O NORMAL OPEN	
N.C NORMAL CLOSE	
..... DISABLE	
SELECT : ▲▼, CHANGE VALUE : + -	

- 1) ALARM INPUT : Select type of alarm sensor connected to DVR unit (N.O or N.C).
 Use direction button and [-] [+] button to set.
 DISABLE represents not to use alarm sensor connected to DVR.
- 2) DURATION : Set the duration of alarm when an ALARM is activated. (0 sec. ~ 300 sec.)

6) BUZZER SETUP

Set parameters for buzzer (On or Off).
Use direction button and [ENTER] button.

KEY BEEP : buzz when button is pressed.
VIDEO LOSS : buzz when video signal is lost.
ALARM ACTIVE : buzz when alarm is activated.
MOTION DETECT : buzz when motion is detected.

User can set all buzzers at On/Off at once
by set ALL at ON/OFF.

BUZZER SETUP	
ALL	ON
KEY BEEP	ON
VIDEO LOSS	ON
ALARM ACTIVE	ON
MOTION DETECT	ON

SELECT : ▲▼, & [ENTER]

7) PASSWORD SETUP

Set user ID and password.

-Use [UP] and [DOWN] button to move to option
and [LEFT] and [RIGHT] button to set user ID.

The password must be consist of 1 to 8 digit
number. Just use numbers button from 1 to 10
on the front panel of DVR unit.

-To change password, user must input current
password and then input new password.
And input again new password to confirm.

- Default value
ADMIN : ' ' (Blank)
MANAGER : '1'
USER 1 : '2'
:
:
USER 8 : '9'

- ※ Change the user PASSWORD in the first operation is recommended.
- ※ In case you forgot PASSWORD, contact dealer of DVR to get instruction to enter into menu to set new PASSWORD.

PASSWORD SETUP	
USER I D	ADMIN
USER PW	-----
NEW PW	-----
CONFIRM	-----

[K1-K10] INPUT PASSWORD
[ENTER] CHANGE PASSWORD

TO EXIT, PRESS [MENU]

8) SYSTEM INFORMATION

DVR system information including firmware
version, hardware version, product ID, etc....

SYSTEM INFORMATION	
S/W VERSION	VER 1.0
H/W VERSION	VER 1.0
PRODUCT ID	01S-2039-001008-AR-01
MASTER	Maxtor 6Y060L0
SLAVE	
CD-R	SAMSUNG CD-R/RW SW-256B

TO EXIT, PRESS [MENU]

5-4. RECORD SETUP

This is the most important configuration of the DVR.
Enter into SYSTEM MENU-RECORD SETUP
and press the [ENTER] button.

1) RECORD CONFIGURATION

Use direction button to move and [-] [+] button to set value.

(1) OVERWRITE : Set overwrite or stop recording when the HDD is full.

(2) MULTIPLE

- DUPLEX : Playback & Ethernet
- TRIPLEX : Playback & Recording & Ethernet

※ Note: DUPLEX MODE is recommended to playback the images at a maximum frame rate.

But, it makes DVR not to record during search.

(3) QUALITY : Set recording picture quality.

Actually it is fixing maximum data size of image for each picture quality in 5 steps as follows.

- BASIC
 - NORMAL
 - ENHANCED
 - FINE
 - SUPER FINE: Default quality set by manufacturer
- In Emergency recording mode, recording quality is SUPER FINE.

To send more images via IP network and longer recording time, set QUALITY at NORMAL or ENHANCED and record at 360x240 or 360x120.

※ Data size of image in PAL system is a little bigger than NTSC system, but the total recording time is same as in NTSC system.

(4) RESOLUTION : Set recording resolution.

- 120 ips at 720x240(NTSC) , 100 ips at 720x288(PAL)
- 240 ips at 360x240(NTSC) , 200 ips at 360x288(PAL)
- 480 ips at 360x120(NTSC) , 400 ips at 360x144(PAL)

※ Images recorded in 360x240(360x288) or 360x120(360x144) are always played in quad mode. It is not possible to see those images in full screen mode in playback.

Recording in half or quad resolution is recommended for higher recording speed, and also to send more images via IP network.

(5) RECORD IN ALARM : Set record speed (skip rate) in ALARM record mode.

(6) RECORD IN MOTION : Set record speed (skip rate) in MOTION record mode.

(7) CONTINUOUS RECORD : Set record speed (skip rate) in CONTINUOUS record mode.

Set record speed (skip rate)

- 1/1x, 1/2x, 1/999x record speed

- ex: 1/2x) R->S->R->S...

- ex: 1/3x) R->S->S->R->S->S->R...

- ex: 1/4x) R->S->S->S->R->S->S... (R : RECORD S : SKIP)

- ex : If record resolution is set at 360x240, 1/1x = 120 ips, 1/2x = 60 ips, 1/3x = 40 ips, etc.

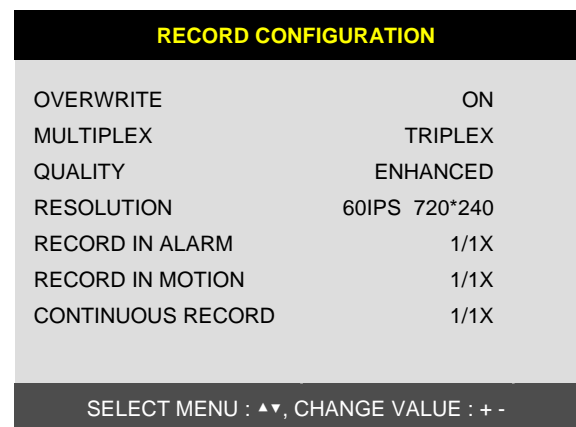
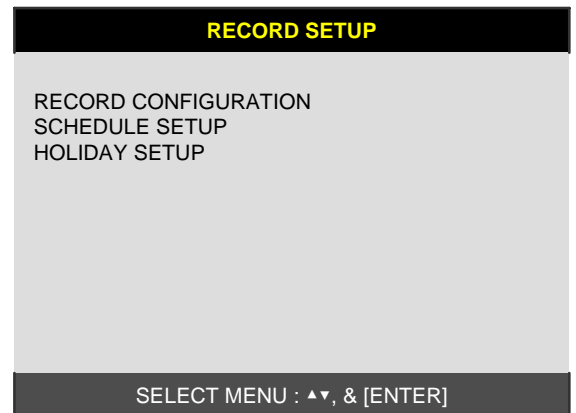

2) SCHEDULE SETUP

Unless you selected other recording mode, DVR system records in Schedule Recording mode. In SCHEDULE REC SETUP, you set type of recording for every time interval of 2 hours in each day of the week. Schedule Recording set by manufacturer is recording continuously at its full recording speed, and it means DVR system record continuously at 120 ips in total at 720x240 resolution. To set Schedule Recording parameters, enter into SYSTEM MENU-RECORD SETUP-SCHEDULE SETUP and Press the [ENTER] button.

(1) SCHEDULE SETUP

Set recording type for each recording time interval for a day of the week (2 hours interval).

SCHEDULE REC SETUP							
	SUN	MON	TUE	WED	THU	FRI	SAT
00-02	-M-	AM-	--C	--C-	--C-	--C	--C
02-04	-M-	AM-	--C	--C	--C	--C	--C
04-06	-M-	AM-	--C	--C	--C	--C	--C
06-08	-M-	AM-	--C	--C	--C	--C	--C
08-10	---	AM-	--C-	--C	--C	--C	--C
10-12	---	AM-	--C	--C	--C	--C	--C
MODE: CELL BY CELL							1 / 2
▲▼◀▶ & [NEXT], EDIT:+-&[MODE] A:ALARM M:MOTION C:CONTINUOUS							

Use [MODE] button to select edit type and move to the time interval of a day of the week you want to change. Press [ENTER] button to select and use [+] or [-] button, to change the record type. To go next page, use [NEXT] button.

※ MODE (Edit type)

CELL BY CELL : Set each time interval of a day of the week

DAY OF THE WEEK : Set a day of the week at once

TIME SLOT : Set a time slot at once

ALL : Set page by page at once

CLEAR ALL: Clear page by page

※ Unless user press [REC] button to record at full resolution and in SUPER FINE picture quality, DVR system records in SCHEDULE Record mode.

※ DEFAULT record mode for each time interval of a day of the week set by manufacturer is CONTINUOUS recording.

※ Record type :

After power on ⇔ Schedule record

Exit from menu ⇔ Schedule record

End of search or playback ⇔ Schedule record

After pressing [STOP] button ⇔ Schedule record

After pressing [REC] button ⇔ Emergency record (Continuous recording in full performance)
(120(100) ips at 720x240(720x288))

3) HOLIDAY SETUP

Users can set national holiday or holidays on calendar to record just as setting for Sunday in SCHEDULE REC SETUP.

Use [MODE] button to select a month and direction button to move to a day, and press [ENTER] button to set a holiday. Then color of date shall be changed to red, as Sunday.

EDIT HOLIDAY : Set as holiday

CLEAR MON DATA : Cancel the holiday set per month

CLEAR ALL DATA : Cancel all holiday set

※ The maximum holidays is 100 days.

HOLIDAY SETUP							
< APR >						000/100	
SUN	MON	TUE	WED	THU	FRI	SAT	
						01	02
03	04	05	06	07	08	09	
10	11	12	13	14	15	16	
17	18	19	20	21	22	23	
24	25	26	27	28	29	30	
MODE : EDIT HOLIDAY SELECT ▲▼◀▶, EDIT [ENTER]&[MODE]							

5-5. BACK-UP

User can back up the recorded data to CD using CD writer installed in DVR. Refer to [START] and [END] of data on HDD and set copy from time, [START], and size of data copied, [SIZE], and move to BURN and press [ENTER] button to start copy.

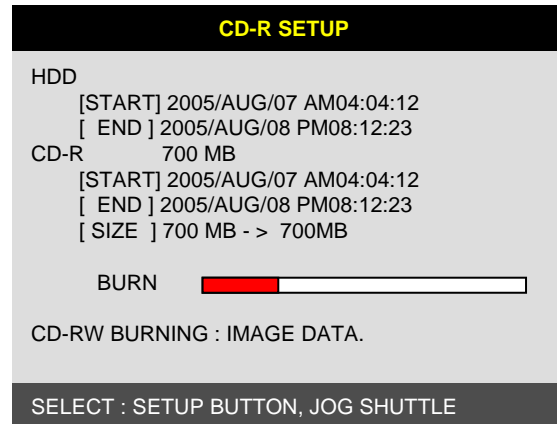
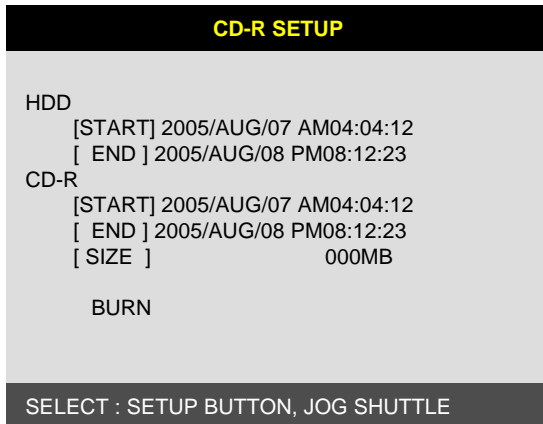

System Status Messages :

- CD-RW DOOR CLOSE. CHECKING CD-R : Blank CD check
- INPUT BLANK CD : CD writer has no blank CD.
- CD-RW DOOR OPEN : Open CD-RW and insert blank CD –R media into CD drive.
- CD-R MEDIA IS DETECTED : Blank CD-R media has been inserted and detected. DVR system will display size of blank CD-R.

After you set [START] time and [SIZE] in CD-R sub-menu and then select BURN, DVR system starts copying images to CD and shows following message.

CD-RW BURNING START
 CD-RW BURNING : LEAD-IN
 CD-RW BURNING : IMAGE DATA
 CD-RW BURNING : CLOSE TRACK
 CD-RW DOOR OPEN

When burning is completed, CD-R media will be ejected automatically.

To copy more images, repeat above process. In the next back-up process, [START] time in CD-R sub-menu shall be [END] time in previous back-up, and you can copy images in series to many CDs as many as you want.

5-6. EXTERNAL DEVICE

Set parameters of external devices connected to DVR, like Ethernet, PTZ camera, RS-232C, etc. Use direction button to move to sub-menu and Press [ENTER] button to set.

1) TCP/IP SETUP

TCP/IP function enables user to see live pictures and recorded pictures via the internet.

(1) IP CONFIG SETUP :

Show the network information assigned to the DVR unit. If the DHCP setup status is AUTOMATIC, user can set the IP port only and if the DHCP setup status is MANUAL, user must set all parameters. For detail procedure of Remote viewer program installation, refer to CHAP. 6 Software program.(Remote viewer software).

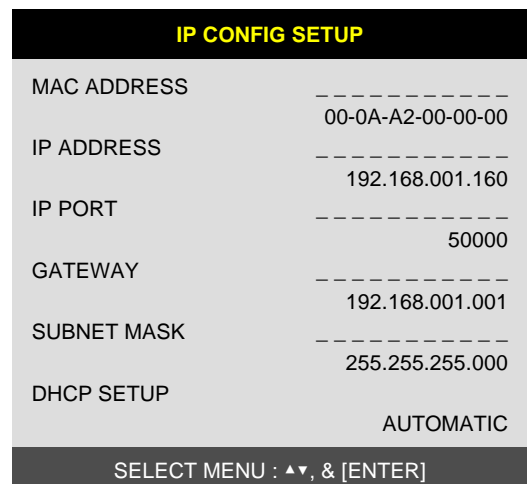

CONNECTION SETUP	
TIMEOUT	200 MSEC
RETRY COUNT	08

SELECT MENU : ▲▼, & [ENTER]

DHCP SETUP	
DHCP MODE	MANUAL
DNS SERVER	000.000.192.168
IP ADDRESS	192.168.001.160
SUBNET MASK	255.255.255.000
GATEWAY	192.168.001.001

SELECT : ▲▼, CHANGE VALUE : + -

(2) CONNECTION SETUP :

- TIME OUT : Adjust TIMEOUT value properly to successfully access to DVMR unit via Internet line. If data transmission speed is high enough, leave TIMEOUT value as set by manufacturer (200 msec), and increase it if data transmission via Internet line is relatively slow. Execute tracert (Tracing Route) in your PC for IP assigned to DVMR unit, and you can figure out how much TIMEOUT value increased.
- RETRY COUNT : Set the retry number of times for network connection.

2) RS-232C SETUP

User can control the DVR via RS-232C port. Connect DVR to PC via RS-232C port and control DVR using keyboard of PC. This function is mainly for programmer who wants to control DVR as part of many devices connected to PC system, as in SI project.

RS-232C SETUP	
SPEED	576000
LENGTH	8
STOP BIT	1
PARITY	NONE

SELECT : ▲▼, CHANGE VALUE : + -

3) PAN/TILT SETUP

It is to set parameters for PTZ camera connected to DVR unit. DVR unit already includes all protocols of well-known PTZ cameras like PELCO D type PTZ camera, and user just select MODEL and set other parameters to control this PTZ cameras, using operation buttons on the front panel of DVR. If PTZ camera whose protocol is not incorporated into this DVR unit, user must input protocol of this PTZ camera by himself. Using USB device port, user can upgrade protocol for PTZ camera.

PAN/TILT SETUP	
COMMAND SETTING	← PTZ camera set
SPEED SETTING	← PTZ speed set

SELECT : ▲▼, & [ENTER]

COMMAND SETTING	
CHANNEL	01
MODEL	PELCO-D
PTZ ID	000
BAUDRATE	2400 BPS
CMD DELAY	1 MSEC
COMMAND	PAN/TILT STOP
LENGTH	0.7
CODE	FF 00 00 00
	00 00 00 00

SELECT : ▲▼, CHANGE VALUE : + -

- 1) CHANNEL : Select channel
- 2) MODEL : Select camera model (protocol type) per each channel
- 3) PTZ ID : Select ID
- 4) BAUDRATE : Select data transmission speed
- 5) CMD DELAY : Select command delay time

5-7. FACTORY DEFAULT

Set the all system parameters as manufacturer first set before delivery. It is a kind of system initialization, and manufacturer recommends to do it when you add new HDD or other changes in system to make all system ready for normal operation.

Use direction button to move and Press [ENTER] button to change parameters. After move to RUN, Press [ENTER] button for actual Factory Default setting.

FACTORY DEFAULT	
ALL	OFF
SCREEN DISPLAY	OFF
CAMERA SETTING	OFF
MOTION SETUP	OFF
PANTILT SERUP	OFF
SCHEDULE SETUP	OFF
CONFIGURATION	OFF
RUN	
SELECT MENU : ▲ ▼, & [ENTER]	

5-8. LANGUAGE SETUP

The menu can be displayed in a number of languages. Press [ENTER] button to select your language.

SYSTEM MENU	
DISPLAY SETUP	
CONFIGURATION	
RECORD SETUP	
EXTERNAL DEVICE	
FACTORY DEFAULT	
LANGUAGE	ENGLISH
SELECT MENU : ▲ ▼, & [ENTER]	

CHAP. 6 Network Setup

6-1. DVR Network Configuration

Now that you are familiar with the equipment and should be able to identify a router from a modem and a Cat5 network cable from a telephone cable, we will proceed to determine the network scenario that fits your current network.

Please call your provider to identify what type of service they are providing you. You will need to know following ;

Upload speed – For your own knowledge for expected frame rates

Download speed – For your own knowledge for expected frame rates

Addressing – For determining what scenario you should follow

Router On Site or Just a Modem – For determining what scenario you should follow

※NOTE : If your provider is using PPPoE (usually DSL providers), you MUST have a router installed on site and follow CASE C for DVR setup and access.

※PLEASE verify Internet access after installing any new equipment (routers, switches, modems, etc.). If possible, use a PC on the network to verify that an Internet connection can be made and that all current configurations on any equipment are up and working properly. Do this before doing ANY configurations with the DVR. We are assuming that your current equipment is configured properly for Internet access.

PC's TCP/IP Setting

Before configuring the DVR, please fill out the information below if applicable ;

Choose any PC on your network and determine its TCP/IP settings;

IP Address : _____(ex.192.168.1.5)

Subnet Mask : _____(ex. 255.255.255.0)

Default Gateway : _____(ex.192.168.1.1)

* For information on how to determine this information, please consult the FAQ page.

Next pages are several network scenarios. Each one is labeled with a letter. Please identify which scenario your current network falls within and follow the instructions for configuring and accessing your DVR via TCP/IP.

The box below represents an area that you can't control. If you are unable or do not have access to your router for port forwarding. Please contact your provider and request them to forward a port to the corresponding DVR IP address :

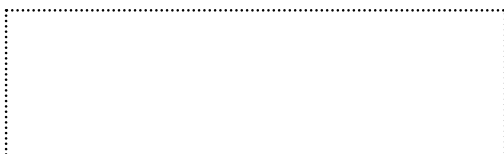

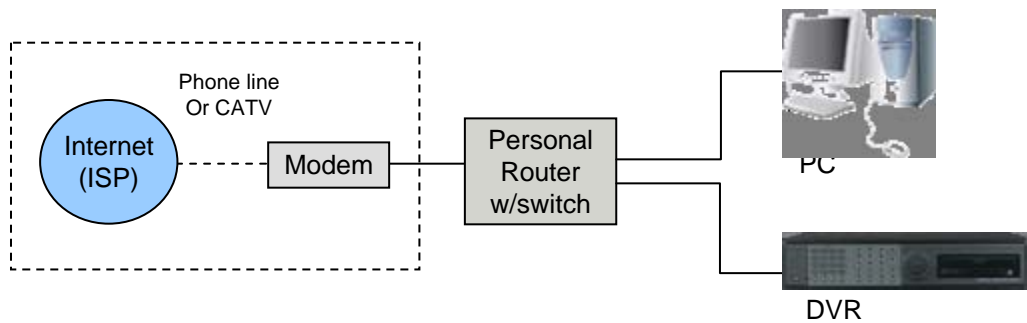
Case A : Single Static IP w/Personal Router**Configure the DVR as follows :**

1. Set the DVR to MANUAL for the TCP/IP settings. Do not use DHCP SETUP for this application or verify that DHCP SETUP is set to MANUAL.
2. IP ADDRESS : assign it a private IP address (ex : 192.168.0.105)
 - a. You need to assign the DVR an IP address just as you would a PC.
 - b. The IP address you assign must be unique to your local network as well as “match” your local network. For information on how to choose a unique IP that matches your network, consult the FAQ.
 - c. The IP address you assign must be a private IP address. For information on what a private IP address is, consult the FAQ.
 - d. When configuring the DVR’s IP address information, the version of firmware within the units may display the IP addresses differently. For simplicity sake, 192.168.1.105 may have to be configured as 192.168.001.105
3. PORT NUMBER : 50000
 - a. 4 channel, 8 channel & 16 channel : This number is stated explicitly.
 - b. For most situations, please use the default 50000 for simplicity.
4. SUBNET MASK : 255.255.255.0 (example)
 - a. Assign the DVR the same exact subnet mask as your PC.
5. GATEWAY : 192.168.0.1(example)
 - a. Assign the DVR the same exact gateway (or default gateway) as your PC.
6. Please DO NOT configure MAC ADDRESS or DHCP SETUP.
7. You will need to forward port 50000 through your router. Please forward port 50000 to the IP ADDRESS you have assigned the DVR.
8. Your DVR is now ready for access.

* For detail information on the above, please consult the FAQ.

Accessing the DVR using the Remote Software for CASE A**LOCALLY :**

To access the DVR locally, that is from your local network on site from where the DVR is installed. Open the remote viewing software and click on the “Settings” button. As far as TCP/IP connectivity is concerned only 4 entries need to be made :

1. IP address : Input the IP address that you assigned the DVR. As in the above example I would input the private IP address of 192.168.0.105
2. Port : 50000(this has to match what is configured in the router and in the DVR)
3. User ID : (always leave the default “ admin “)
4. Password : this must match what is configured in the DVR
 - a) 4,8,16 channel default : Blank (NO PASSWORD)

REMOTELY :

To access the DVR remotely, that is from outside your local network, follow the above directions for accessing locally, except for the IP address. For CASE A, you have received a static IP from your Internet provider. That static IP address is what you must enter into the software for connectivity to take place (NOT the IP of the DVR). Contact your provider if you have misplaced the forms stating your static IP address. Since you are accessing the DVR via a router, you must enter the router's WAN IP address which is the exactly the same as the static IP that you have received from your Internet provider.

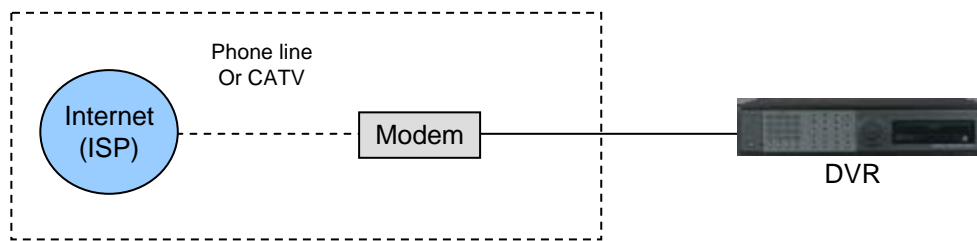
Case B : Single Static IP Directly Connected to the DVR**Configure the DVR as follows :**

1. Set the DVR to MANUAL for the TCP/IP settings. Do not use DHCP SETUP for this application or verify that DHCP SETUP is set to MANUAL.
2. IP ADDRESS : assign it a public IP address (ex : 24.106.1.195)
 - a. You need to assign the DVR an IP address just as you would a PC.
 - b. The static IP address that you received from your Internet provider is the address that you will assign this DVR, if you do not know this IP address please contact your provider.
 - c. When configuring the DVR's IP address information, the version of firmware within the units may display the IP addresses differently. For simplicity sake, 24.106.1.195 may have to be configured as 24.106.001.195
3. PORT NUMBER : 50000
 - a. 4 channel, 8 channel & 16 channel : This number is stated explicitly.
 - b. For most situations, please use the default 50000 for simplicity.
4. SUBNET MASK : 255.255.255.240 (example)
 - a. Along with your static IP address you should have received your subnet mask from your Internet provider. Please use that subnet mask when configuring the DVR. If you did not receive this information contact your service provider.
5. GATEWAY : 24.106.1.193(example)
 - a. Along with your static IP address you should have received your gateway or default gateway from your Internet provider. Please use that gateway when configuring the DVR. If you did not receive this information contact your service provider.
6. Please DO NOT configure MAC ADDRESS or DHCP SETUP.
7. Your DVR is now ready for access.

Accessing the DVR using the Remote Software for CASE A**LOCALLY :**

You cannot physically access the unit locally since a router was not used in this case.

REMOTELY :

To access the DVR remotely, open the remote viewing software and click on the “Settings” button. As far as TCP/IP connectivity is concerned only 4 entries need to be made :

For CASE A, you have received a static IP from your Internet provider. That static IP address is what you must enter into the software for connectivity to take place (this should be the same IP address configured in the DVR). Contact your provider if you have misplaced the forms stating your static IP address. As in the above example I would input the :

1. Public IP address of 24.106.1.195
2. Port : 50000(this has to match what is configured in the DVR)
3. User ID : (always leave the default “ admin “)
4. Password : this must match what is configured in the DVR
 - a) 4,8,16 channel default : Blank (NO PASSWORD)

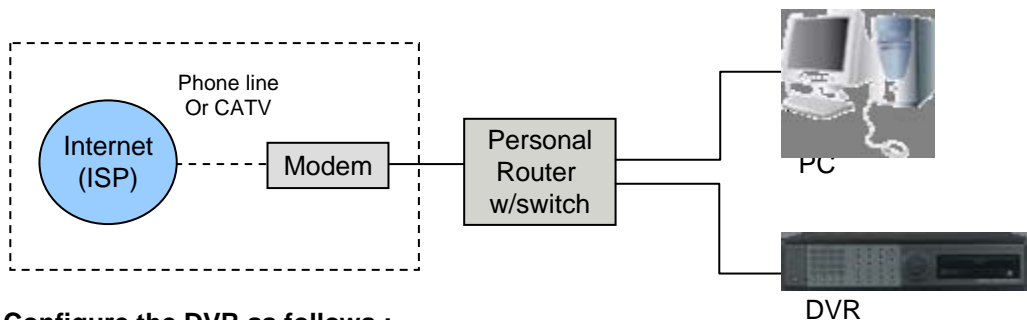
Case C : Dynamic or PPPoE IP w/Personal Router**Configure the DVR as follows :**

1. Set the DVR to MANUAL for the TCP/IP settings. Do not use DHCP SETUP for this application or verify that DHCP SETUP is set to MANUAL.
2. IP ADDRESS : assign it a private IP address (ex : 192.168.0.105)
 - a. You need to assign the DVR an IP address just as you would a PC.
 - b. The IP address you assign must be unique to your local network as well as “match” your local network. For information on how to choose a unique IP that matches your network, consult the FAQ.
 - c. The IP address you assign must be a private IP address. For information on what a private IP address is, consult the FAQ.
 - d. When configuring the DVR’s IP address information, the version of firmware within the units may display the IP addresses differently. For simplicity sake, 192.168.1.105 may have to be configured as 192.168.001.105
3. PORT NUMBER : 50000
 - a. 4 channel, 8 channel & 16 channel : This number is stated explicitly.
 - b. For most situations, please use the default 50000 for simplicity.
4. SUBNET MASK : 255.255.255.0 (example)
 - a. Assign the DVR the same exact subnet mask as your PC.
5. GATEWAY : 192.168.0.1(example)
 - a. Assign the DVR the same exact gateway (or default gateway) as your PC.
6. Please DO NOT configure MAC ADDRESS or DHCP SETUP.
7. You will need to forward port 50000 through your router. Please forward port 50000 to the IP ADDRESS you have assigned the DVR.
8. Your DVR is now ready for access.

* For detail information on the above, please consult the FAQ.

Accessing the DVR using the Remote Software for CASE C

LOCALLY :

To access the DVR locally, that is from your local network on site from where the DVR is installed. Open the remote viewing software and click on the “Settings” button. As far as TCP/IP connectivity is concerned only 4 entries need to be made :

1. IP address : Input the IP address that you assigned the DVR. As in the above example I would input the private IP address of 192.168.0.105
2. Port : 50000(this has to match what is configured in the router and in the DVR)
3. User ID : (always leave the default “ admin “)
4. Password : this must match what is configured in the DVR
 - a) 4,8,16 channel default : Blank (NO PASSWORD)

REMOTELY :

To access the DVR remotely, that is from outside your local network, follow the above directions for accessing locally, except for the IP address. For CASE C, you have received a dynamic or PPPoE IP from your Internet provider. That static IP address is what you must enter into the software for connectivity to take place (NOT the IP of the DVR). You may be able to contact your provider to determine your current IP address. You can also try accessing your router and locating the status page that should list the WAN or Internet IP address. Since you are accessing the DVR via a router, you must enter the router’s WAN IP address which is the exactly the same as the IP that you have dynamically received from your Internet provider. Take into consideration that this scenario is not recommended, due to the nature of dynamic addressing. Dynamic address may change randomly or on power failures. If you are unable to connect suddenly, first verify that your dynamic IP address has not changed.

Case D : Multiple Static IPs w/Personal Router

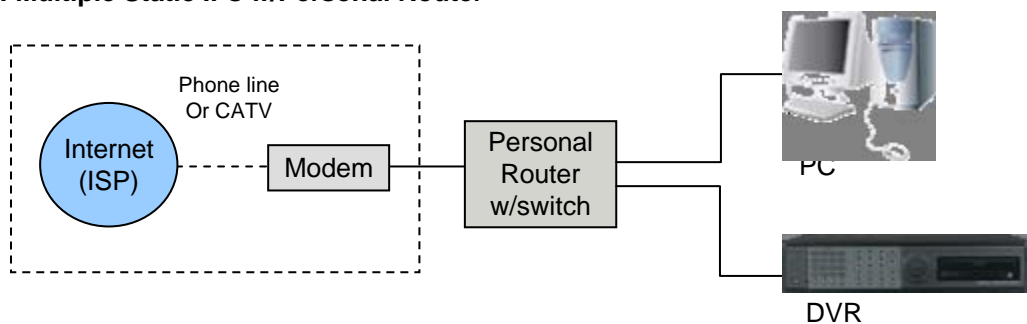

Configure the DVR as follows :

1. Set the DVR to MANUAL for the TCP/IP settings. Do not use DHCP SETUP for this application or verify that DHCP SETUP is set to MANUAL.
2. IP ADDRESS : assign it a public IP address (ex : 24.106.1.195)
 - a. You need to assign the DVR an IP address just as you would a PC.
 - b. For this case you must have received several available static IP addresses. Of those, choose one that is not in use to which you can assign the DVR, if you do not know your available IP addresses please contact your provider.
 - c. When configuring the DVR’s IP address information, the version of firmware within the units may display the IP addresses differently. For simplicity sake, 24.106.1.195 may have to be configured as 24.106.001.195
3. PORT NUMBER : 50000
 - a. 4 channel, 8 channel & 16 channel : This number is stated explicitly.
 - b. For most situations, please use the default 50000 for simplicity.

4. SUBNET MASK : 255.255.255.240 (example)
 - a. Along with your static IP addresses you should have received your subnet mask from your Internet provider. Please use that subnet mask when configuring the DVR. If you did not receive this information contact your service provider.
5. GATEWAY : 24.106.1.193(example)
 - a. Along with your static IP addresses you should have received your gateway or default gateway from your Internet provider. Please use that gateway when configuring the DVR. If you did not receive this information contact your service provider.
6. Please DO NOT configure MAC ADDRESS or DHCP SETUP.
7. Your DVR is now ready for access.

Accessing the DVR using the Remote Software for CASE D

LOCALLY :

To access the DVR locally, open the remote viewing software and click on the “Settings” button. As far as TCP/IP connectivity is concerned only 4 entries need to be made. For CASE D, you have received a static IP from your Internet provider. That static IP address is what you must enter into the software for connectivity to take place (this should be the same IP address configured in the DVR). Contact your provider if you have misplaced the forms stating your static IP address. As in the above example I would input the :

1. Public IP address of 24.106.1.195
2. Port : 50000(this has to match what is configured in the DVR)
3. User ID : (always leave the default “ admin “)
4. Password : this must match what is configured in the DVR
 - a) 4,8,16 channel default : Blank (NO PASSWORD)

REMOTELY :

To access the DVR remotely, just follow the same instructions for local access.

Case E : Dynamic IP Directly Connect to the DVR with High Speed Cable

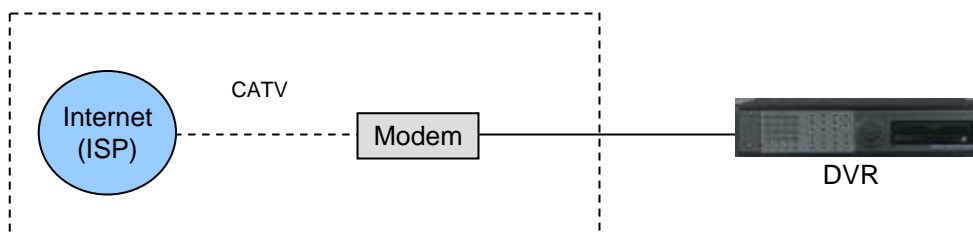

Configure the DVR as follows :

For this application you can still use the DVR for remote access, yet you will have to verify the IP address within the DVR on a continuous basis to ensure the IP address hasn't changed. This setup will not work with most Dynamic DSLDKDKD providers. In any instance in which the DVR cannot detect an IP, please use CASE C.

1. Unplug the power from the modem.
2. Turn off the DVR.
3. After waiting 5 minutes, power on the modem followed by the DVR.
4. Enter the TCP/IP Setup menu.
5. Enter DHCP Setup.
6. Select IP DETECT MODE.
7. Press ENTER.
8. It should now display DHCP.
9. Cursor down to REQUEST IP and hit ENTER.
10. The Unit will now send a request to a DHCP server asking for IP address information.
 - a. If it is unable to detect an IP address, contact your ISP to reset the modem, before trying again.
 - b. After an IP has been received, the lease time listed under IP LEASE TIME is just notifying you when the DVR will try to renew the IP address. Typically it will try to receive the same IP, but it is a good idea to check your IP on a continuous basis.
11. Exit DHCP SETUP.
12. Select IP ADDRESS to determine the IP address the unit has received.
13. The DVR is now ready for access.

Accessing the DVR using the Remote Software for CASE E**LOCALLY :**

You cannot physically access the unit locally since a router was not used in this case.

REMOTELY :

To access the DVR remotely, open the remote viewing software and click on the "Settings" button. As far as TCP/IP connectivity is concerned only 4 entries need to be made.

For CASE E, you have received a dynamic IP from your Internet provider. That dynamic IP address is what you must enter into the software for connectivity to take place (this should be the same IP address configured in the DVR). Check your DVR's current IP address for access :

1. IP address : 24.106.1.195(example)
2. Port : 50000(this has to match what is configured in the DVR)
3. User ID : (always leave the default " admin ")
4. Password : this must match what is configured in the DVR
 - a) 4,8,16 channel default : Blank (NO PASSWORD)

6-2. Remote Viewer program

MAIN INTERFACE

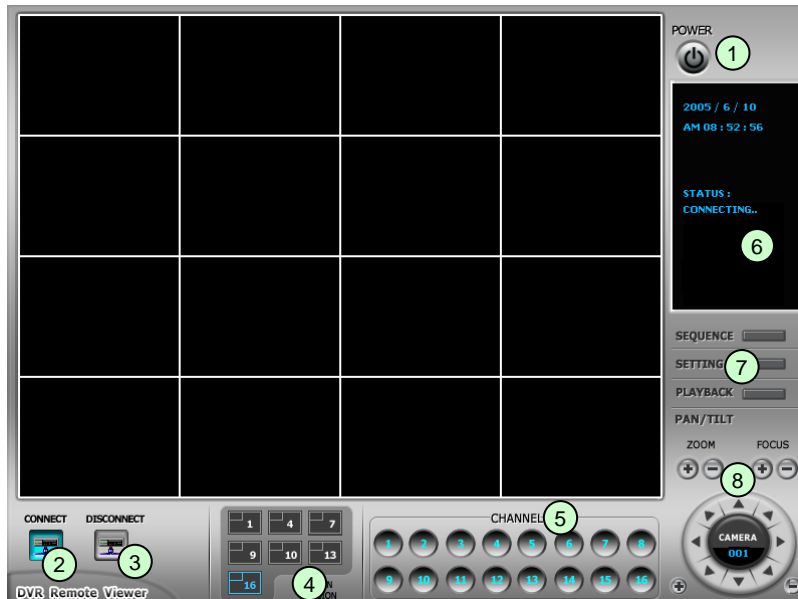

- ① - **Power switch** : Press the Power switch to exit the program. Please disconnect the live feed before powering off the software
- ② - **Connect button** : Press the Connect button to view the live images from the DVR. These are the same images being displayed on the monitor of the DVR, with a delay depending on your internet connection at both the DVR location and from where you're currently accessing.
- ③ - **Disconnect button** : Press this button to disconnect from the DVR unit. Then you may power off the software.
- ④ - **Screen Division button** : Select how many channels to view simultaneously (single, 4-split, 9-split, or 16-split). When you select a view you will see the Channel Numbers highlighted which determine what channels are currently being viewed.
- ⑤ - **Channel number button** : Select the channel that you want to view based on what Screen Division view is enabled.
- ⑥ - **Status window** : Display's the current time and date based. The date is in the format : Year/Month/Day. You will also see the status of your connection.
- ⑦ - **Setting, Playback, and Sequence buttons** ;
 - a. Setting : Enables the software configuration screen.
 - b. Playback : Enables the remote playback screen.
 - c. Sequence : When in single channel view, hitting the sequence button will sequence through all active channels at a speed specified in the settings menu.
- ⑧ - **PTZ control** : You can control a PTZ camera via the software with these controls.
 - a. First, you must input or configure the specific PTZ protocol into the software in order to communicate with the PTZ device.
 - b. When you press any of the controls for the PTZ, please press and hold the button for 1-2 seconds per instance to compensate for the data transmission rate. If you do not and instead simply click the PTZ buttons, you may get undesired results (having the requested operation transmitted repeatedly, regardless of your intention).
 - c. The plus and minus buttons send the PTZ commands to the corresponding PTZ camera ID.

Setting Screen

Name (LABEL) : This just identifies your settings. The settings are automatically saved under this label when you hit 'OK'.

IP Address : Based on your network scenario and from where you're accessing, enter the appropriate IP address.

PORT : Enter the Port Number you assigned the DVR.

ID : Always enter 'admin'

Password : This must match the password on the DVR. For simplicity, just use numbers.

PTZ TYPE : If using PTZ device or camera, select the protocol your PTZ camera is using from the list of preconfigured protocols.

Circular Monitoring Interval : This indicates the speed of the channels sequence when the SEQUENCE button is used from the main interface.

PTZ Baud Rate : Enter the Baud Rate of your PTZ camera.

Run in full screen mode : When checked, this will enable the program to re-adjust the interface to completely fill your computer screen.

Set Path to Save Downloaded image : Determines the location and folder on your PC where the downloaded video clips are stored. If you do not specify a valid location, The viewer program will save all files in the default location of C:\Program Files\DvrRemoteViewer4

PIAYBACK INTERFACE through Remote Viewer

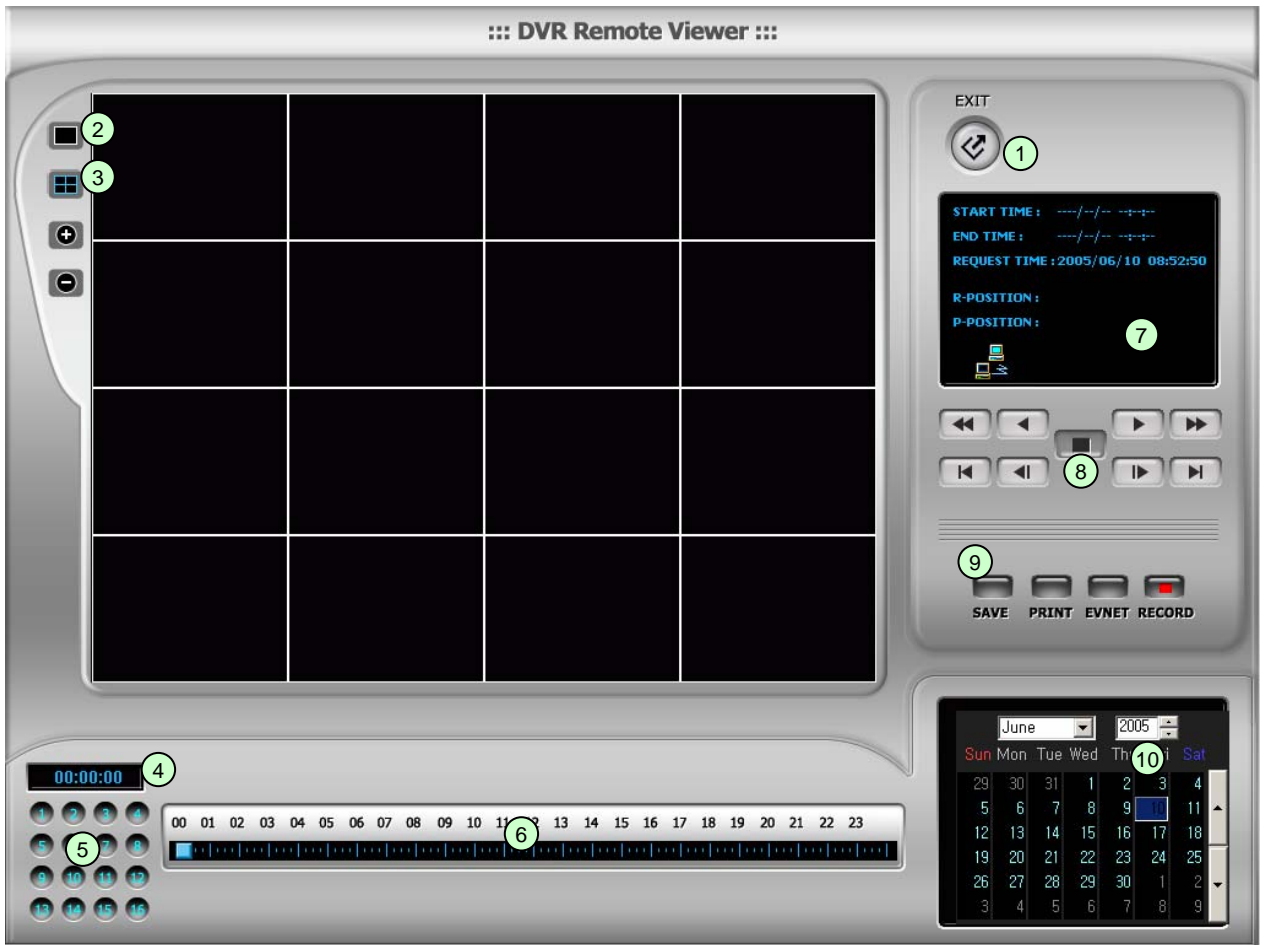

Function of each button in Search window.

- ① **Exit** : Exit to live window.
- ② **Full screen** : Select a certain camera to view in full screen.
- ③ **Quad** : To view quad mode (4 channels at the same time)
- ④ **Time** : The recording time & date information of the pictures which is being played.
- ⑤ **Channel selection** : Select each camera.
- ⑥ **Time selection** : Select a time from which user want to see. The playback will be started from this point.(drag the point using mouse)
- ⑦ **Start and end time** : Indicate record starting time and end time of images on HDD
- ⑧ **Other operating button** : Refer to the next page description.

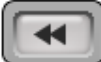

 : Play Fast backward

 : Play backward(1X)

 : Play Forward(1X)

 : Play Fast Forward

 : Stop playback

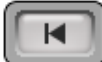
 : Move to the start of recording

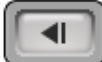
 : Move to the previous hour

 : Move to the afterward hour

 : Move to the end of recording

⑨ : Command button.

- a) **SAVE** : After pressing the Stop button, click SAVE button to save the currently viewed image in jpg format.
- b) **PRINT** : After pressing the Stop button, click PRINT button to print the currently viewed image.
- c) **EVENT** : To be available later
- d) **RECORD** : Press this button to download playback images transmitted from DVMR unit into your PC. Images downloaded is saved in the folder set in Remote Viewer Setup. Press the RECORD button again to stop downloading. User can see saved images using Media Player.

10 : Calendar

Use this to select the date you wish to search. The filled in square outlines the date that is at the beginning of the hard drives. The outlined square indicates the data at the end of the hard drives. Select the date you wish to view. Verify a filled in square for that particular date. If an invalid date is selected it will default to the beginning of the hard drive(s).

Notice : To see continuous live view, it is recommended to set recording mode of DVR unit in continuous recording mode. If it is set at motion recording mode, image transmission is done only when motion is detected, and user only see still images for most of cases.

Notice : While user access to DVR unit via IP network to see live view, the DVR unit continues to record. While user see recorded images via IP, DVR unit shows live images through monitor connected to DVR unit. This is only for TRIPLEX MODE.

6-3. Back-up CD Player

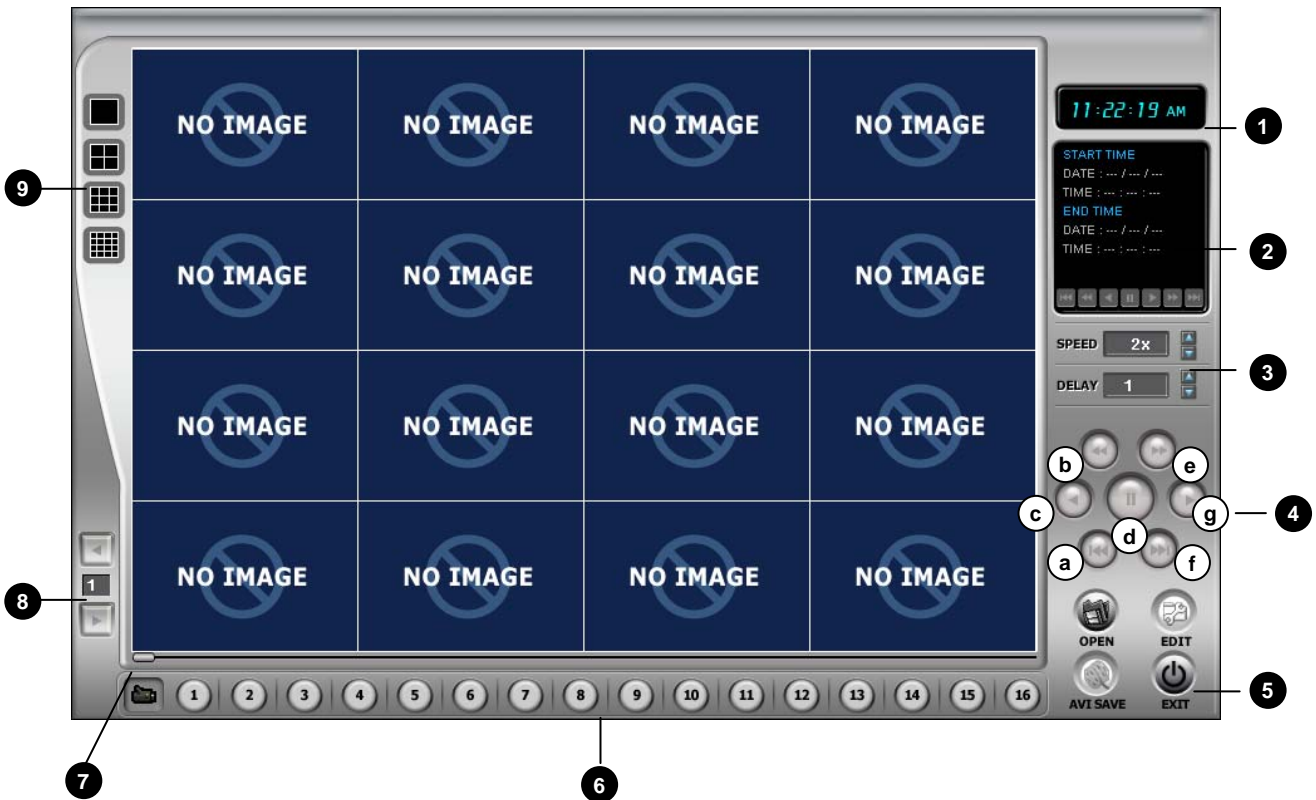

DVR units are with a built-in CD-RW, and user can copy images to CD.

Using back-up CD player, user can see images on back-up CD, and function of each button in Back-up CD player is as below.

- 1 **Time** : Current time.
- 2 **Status Window** : Start & End of time & date, Status of operating button.
When user play forward/backward, recorded time will appear.
- 3 **Play Speed button** : User can adjust play speed by pressing up/down button.
(2X,4X,8X,16X,32X,64X) Delay : (1, 1/2, 1/4, 1/8, 1/16)
- 4 **Operation button** : User can search recorded data using these buttons.
 - a) Move the slide bar to start position
 - b) Play fast backward in preset speed
 - c) Play backward at 1x speed
 - d) Pause
 - e) Play forward at 1x speed
 - f) Play fast forward in preset speed
 - g) Move the slide bar to end position
- 5 **Function button**
 - a) OPEN : Open the Back-up CD Player.
 - b) EDIT : User can edit, save and print recorded image on Edit mode. This edit button will work when you selected one of 16 cameras.
 - c) EXIT : Exit from Back-up CD Player.
- 6 **Channel button** : Select channel to see pictures in full screen.
- 7 **Slide Bar** : Move to a point from which user want to see.
- 8 **Page button** : This button is just working when screen-division is 4-split in 8 ch DVR, or 4-split or 8-split in 16 ch DVR. Moves to next page.
- 9 **Screen division** : 1/4/9/16

Image EDIT

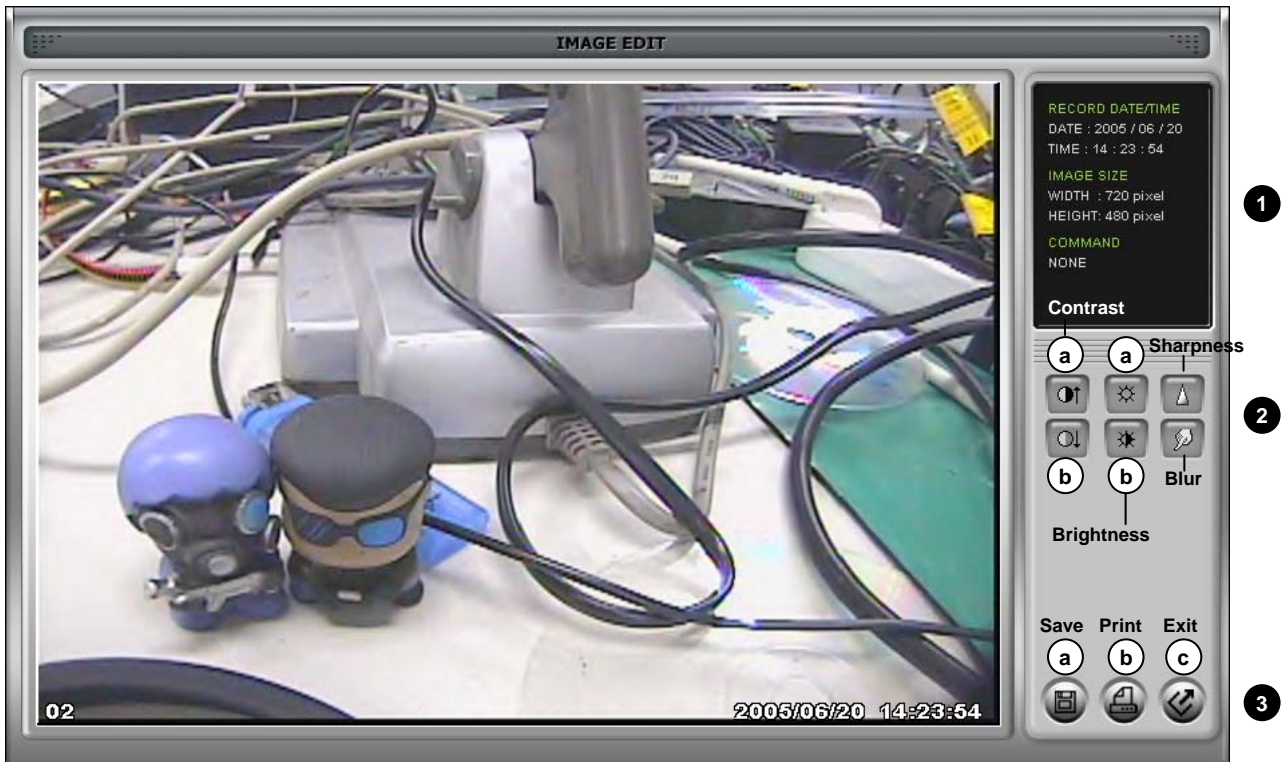

1. Image edit status window : Shows record time & date, Image size, Command status.

2. Edit button : User can adjust color tone of copied images using this button.

- Contrast :
 - a) make bright part of image brighter and dark part of image darker
 - b) To reduce light and shade, lower contrast a little
- Brightness
 - a) make an image brighter
 - b) make an image darker
- Sharpness : give sharp-edge effect
- Blur : make an image soft

3. Function button

- a) Save : User can save an image in JPEG format. It is saved in the folder where you installed back-up CD player.
- b) Print : User can print current image user selected
- c) EXIT : Return to Back-up CD Player mode.

6-4. Frequently Asked Questions

F A Q

How do I determine my PC's TCP/IP settings?

For Window 98 / Me Users

1. Click on the Start Menu, select RUN
2. Type 'winipcfg' (without the quotes), hit Enter
3. Use the drop down list to select your 10/100 Fast Ethernet Adapter(not the PPP adapter)
4. Now you will see your IP Address, Subnet Mask, and Default Gateway information

For Window 2000 / XP

1. Click on the Start Menu, select RUN
2. Type 'cmd' (without the quotes), hit Enter
3. The command prompt will appear. At the prompt type – "ipconfig"(without the quotes)
4. This will list your current IP address, subnet mask, and default gateway.

How do I choose a unique IP that matches my network?

For your home or small office, ensure that all devices on your network are running. Chose an IP address that you wish to assign the DVR. To ensure the IP address that you will assign the DVR matches your network, review the "PC's TCP/IP settings" that you had recorded earlier. See some examples below."

- If your "IP Address" entry in "PC's TCP/IP Settings" was 192.168.0.y and your "Subnet Mask" was 255.255.255.0 then use 192.168.0.x for your DVR's IP Address ("x" meaning any number between 2-254 that you wish, as long as it passes the "PING" test).

- If your "IP Address" entry in " PC's TCP/IP Settings" was 192.168.1.y and your "Subnet Mask" was 255.255.255.0 then use 192.168.1.x for your DVR's IP Address ("x" meaning any number between 2-254 that you wish, as long as it passes the "PING" test).

After choosing an appropriate IP address, 'PING' the IP address that you plan to assign to the DVR. If you receive a "Request timed out", then you may use that IP address (the PING test has passed).

* If your "IP Address" entry under "PC's TCP/IP Settings" is not a 192.168.z.y address with a "Subnet Mask" of 255.255.255.0 then please contact our Support Center.

** If your "IP Address" entry under "PC's TCP/IP Settings" is not a 192.168.z.y address, please contact our Support Center.

How do I "PING" an IP address ?

1. Open an MS-DOS (or Command) prompt.
2. At the prompt type – "ping xxx.xxx.xxx.xxx" (without the quotes and replace the x's with an IP address)
3. Press Enter

How do I “PING” an IP address ?

1. Open an MS-DOS (or Command) prompt
2. At the prompt type – “ping xxx.xxx.xxx.xxx” (without the quotes and replace the x's with an IP address)
3. Press Enter

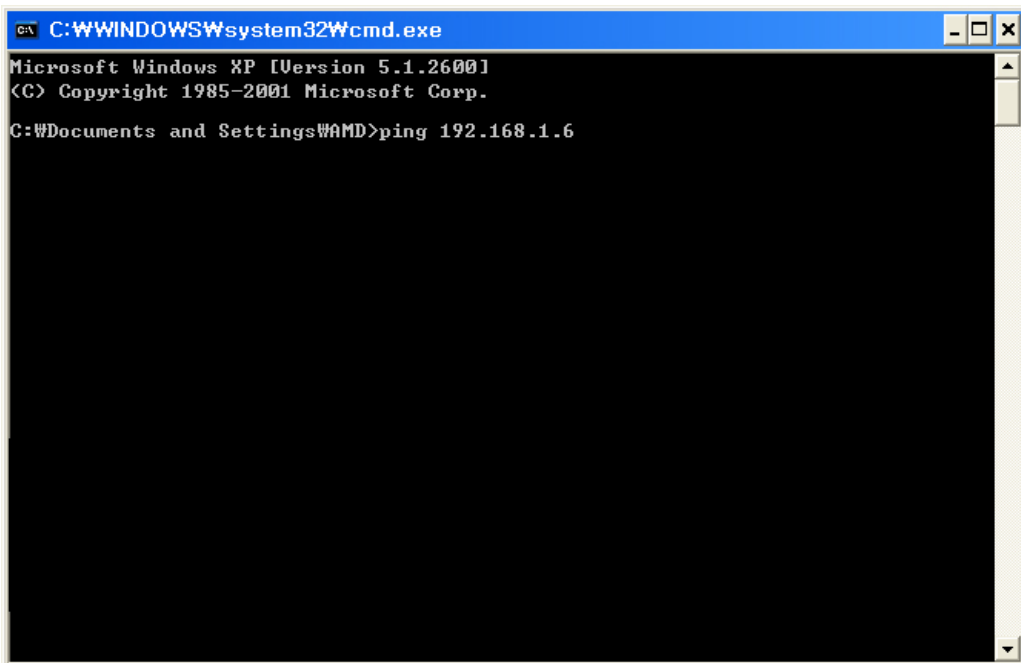

```

C:\WINDOWS\system32\cmd.exe
Microsoft Windows XP [Version 5.1.2600]
(C) Copyright 1985-2001 Microsoft Corp.
C:\Documents and Settings\AMD>ping 192.168.1.6

```

Ping Result. When testing for a usable IP address, verify that you get a “Request timed out” message. This ensures that the IP address that you have tested is not being used by another device on your network.

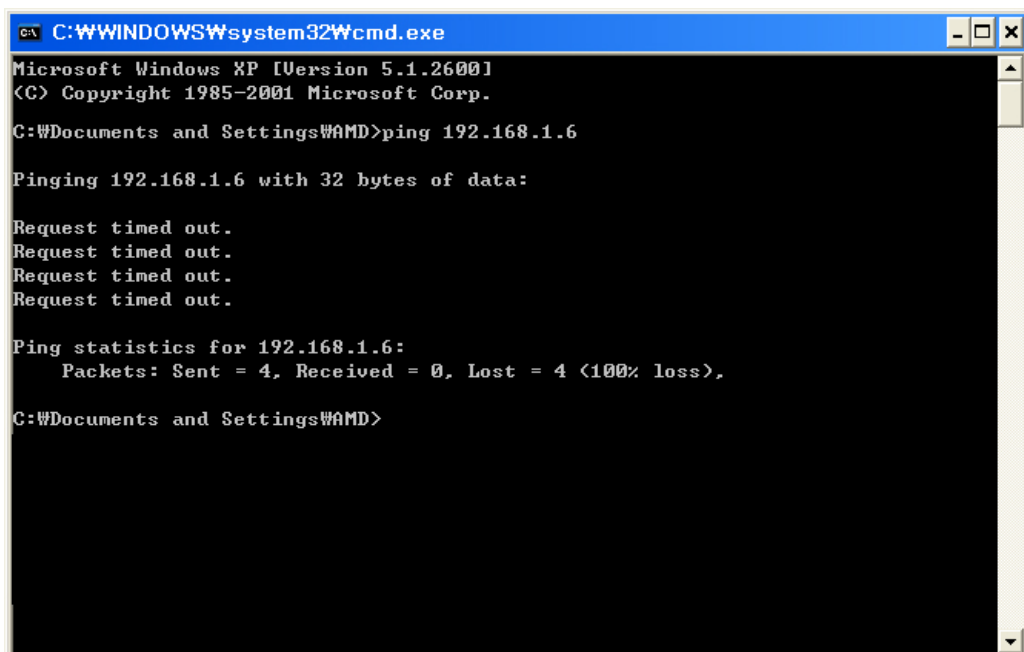

```

C:\WINDOWS\system32\cmd.exe
Microsoft Windows XP [Version 5.1.2600]
(C) Copyright 1985-2001 Microsoft Corp.
C:\Documents and Settings\AMD>ping 192.168.1.6

Pinging 192.168.1.6 with 32 bytes of data:

Request timed out.
Request timed out.
Request timed out.
Request timed out.

Ping statistics for 192.168.1.6:
    Packets: Sent = 4, Received = 0, Lost = 4 (100% loss),

C:\Documents and Settings\AMD>

```

How do I open an MS-DOS or Command Prompt ?

Windows 98/Me : Start -> Programs -> Accessories -> MS-DOS prompt

Windows 2000/XP : Start -> (All) Programs -> Accessories -> Command Prompt

How do I choose a private IP address : Below lists the ranges for private addresses.

Private Class A address space : 10.0.0.0 – 10.255.255.255

Private Class B address space : 172.16.0.0 – 172.31.255.255

Private Class C address space : 192.168.0.0 – 192.168.255.255

For most cases you will choose a private IP address that falls in the Class C address space.
(ex. 192.168.1.x or 192.168.0.x)

How do I forward a port in my router?

For cases A&C you must forward a TCP port through your router. This port is the Port Number specified in the DVR. For most cases you should be able to leave the default at 50000.

Every router has a different procedure for forwarding ports. Please consult your router's user guide on how to correctly configure Port Forwarding.

Can I configure my DVMR for remote access using a Dial-Up connection?

Yes, it is possible, but not recommended. With a live video feed, the bandwidth that a dial-up connection provides is very poor. In addition, you will have to install a device that allows your DVR to connect directly to your dial-up phone line (roughly \$200).

Why is my remote video jerky?

The frame rates received via the Internet are all dependent on your connection condition and speed at both the DVR site and the location from where you are accessing the DVR. The fastest frame rates are achieved locally.

Important Notes Regarding the Remote Viewer and the DVR

When you are in SCAN MODE and are playing back data, you are actually accessing the DVR remotely and placing the unit itself in playback mode, which enables DVR to record the images.

When selecting a date/time to play back. First, ensure that the stop button has been pressed (screen should have no images displayed). Next, select the date you wish to view and verify that it is a valid date on the hard drive and that the selected data is outlined with the box filled in. Then, select the time you wish to access for that particular date. Finally, hit the single-arrow play or double-arrow play button.

To see continuous live view, we recommend NOT setting the DVR for motion detection. The remote viewer only sends images when there is motion and this motion is not fluid. The remote SCAN MODE option still operates as normal. We recommend only using the remote playback feature if you set the DVR for Continuous Record.

The DVR still records images in the remote scan mode, but recording rates drop by a small amount. Therefore, we recommend remote access to DVR for Scan when needed.

The remote viewer is only compatible with Windows operating systems.

If the connection is lost during remote playback, exit SCAN MODE, reconnect to the live view, then re-enter SCAN MODE.

CHAP. 7 Specifications

- The best picture quality in Playback(JPEG-2000)
- Real time live display in all channels
- 16 channel video 480(400)ips recording capability
- Triplex (Playback/Recording/Ethernet)
- Multi-language menu
- Remote monitoring and download through network
- Convenient search function with Jog/shuttle
- VGA option available (Supporting TFT LCD Monitor)
- USB (Device) port for firmware upgrade
- Easy PTZ camera control by pre-assigned buttons
- Password Protection
- Remote Controller

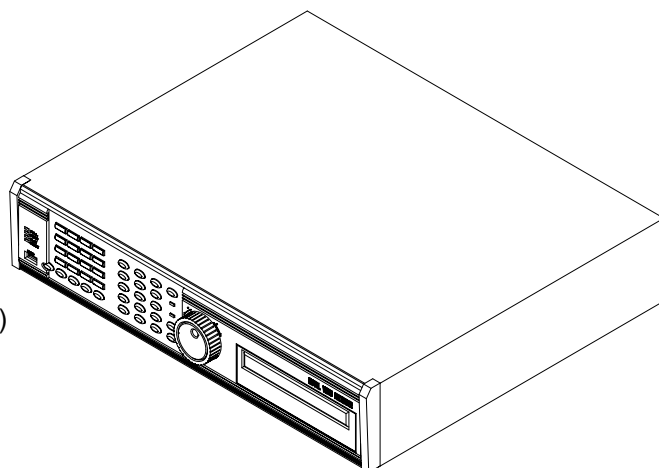

Multiplex function		Triplex (Playback/Recording/Ethernet)	
Storage	Internal	HDD	Up to 2 HDDs with no limitation in capacity
		CD-RW	For Backup (Can be replaced by 3rd HDD)
Video	Inputs	Composite	16Ch
	Outputs	Composite	2Ch (Monitor / VCR)
		VGA	1Ch (Supporting TFT LCD Monitor/Option)
		Loop out	16Ch
	Compression	JPEG-2000	
	Compression Rate (Image size fixed)	Basic	
		Normal	
		Enhanced	
		Super Fine	
	Display Speed	Real Time display	
Recording /Search	Recording Mode	Time, Motion, schedule, Alarm	
	Search	Event Search, Date/Time Search, Jog/Shuttle Search	
	Recording Speed (NTSC/PAL)	Full (120/100), Dual (240/200), Quad(480/400)	
	Recording Resolution (NTSC/PAL)	Full (720x240/720x288), Dual (360x240/360x288), Quad (360x120/360x144)	
Multi-language	English, Spanish, German, Italy, France, to be added more		
Switching Interval	1~99 sec selectable		
Live Division Screen	1 / 4/ 6/ 8/ 9/ 13/ 16 Split		
	Digital Zoom, Freeze function available in Live mode, PIP		
Alarm	Inputs	16 Alarms (NO/NC selectable in SETUP menu)	
	Outputs	1 (NO/NC)	
	Post Alarm	Duration of alarm output : 1 sec ~ 59 sec selectable	
Motion Detection	Area division : 16 x12 / Detection Division : 32 x 24		
Network	Ethernet (TCP/IP), Remote viewer program included		
Backup	VCR, CD-RW back-up, Download via IP Network		
PTZ Control	RS-485, Key Control(Key assigned for each PTZ command)		
Firmware upgrade	USB port for firmware upgrade, CD-R		
Serial I/F	RS-485	For PTZ camera control	
	RS-232C	For operation using keyboard of PC	
Power Requirements	DC 12V 5A Adaptor		
Weight	8.5kg		
Dimensions(WXHXD)mm	436 X 396 X 88		
Packing	600 X 520 X 180		

Design and specifications are subjected to changes without notice

MEMO :



Best Picture Quality - JPEG2000