



**10.2-inch Combo Digital Video Recorder
Quick Start Guide**

Table of Contents

1 Hardware Installation and Connection	6
1.1 Check Unpacked Combo DVR	6
1.2 About Front Panel and Rear Panel	6
1.3 Device Installation	6
1.4 Data Cable Connection	6
1.5 HDD Installation	7
1.6 Dimensions	8
1.7 Front Panel, Side Panel and Rear Panel	9
1.8 Connection Sample	10
1.9 Alarm Input and Output Connection	11
1.9.1 Alarm Input and Output Details	11
1.9.2 Alarm Input Port	12
1.9.3 Alarm Output Port	12
2 Overview of Navigation and Controls	13
2.1 Login, Logout & Main Menu	13
2.1.1 Login	13
2.1.2 Main Menu	13
2.1.3 Shutdown	14
2.1.4 Auto Resume after Power Failure	14
2.1.5 Replace Button Battery	14
2.2 Live Viewing	14
2.3 Schedule	15
2.4 Manual Record	16
2.5 Encode	16
2.5.1 Snapshot	17
2.5.2 Image FTP	18
2.6 Search and Playback	18
2.6.1 Basic Operation	19
2.7 Network Setup	21
2.8 Pan/Tilt/Zoom	22
2.8.1 PTZ Setup	22
2.8.2 PTZ Operation	22
2.8.3 3D Intelligent Positioning Key	23
3 Web Operation	25
3.1 Network Connection	25
3.2 Login	25
3.3 Main Window	25

Welcome

Thank you for purchasing our combo DVR!

This quick start guide will help you become familiar with our combo DVR in a very short time. Here you can find hardware installation, cable connection information and general operations such as system setup, record, search, backup, alarm setup, PTZ operation, also here you can find web operation instruction.

Before installation and operation, please read the following safeguard and warning carefully!

Important Safeguards and Warnings

1 . Electrical safety

All installation and operation here should conform to your local electrical safety codes. We assume no liability or responsibility for all the fires or electrical shock caused by improper handling or installation.

2 . Transportation security

Heavy stress, violent vibration or water splash are not allowed during transportation, storage and installation.

3 . Installation

Keep upwards. Handle with care.
Do not apply power to the combo DVR before completing installation.
Do not place objects on the combo DVR.

4 . Qualified engineers needed

All the examination and repair work should be done by the qualified service engineers. We are not liable for any problems caused by unauthorized modifications or attempted repair.

5 . Environment

This series product working temperature ranges from -5°C to 55°C.
The combo DVR should be installed in a cool, dry place away from direct sunlight, inflammable, explosive substances and etc.
Please unplug the power cable in case there is strong wind or lightning.

6. Accessories

Be sure to use all the accessories recommended by manufacturer.
Before installation, please open the package and check all the components are included.
Contact your local retailer ASAP if something is broken in your package.

7. About the LCD

During the installation, do not push or squeeze the LCD or its rim; it may result in LCD damage. During the operation or storage, please avoid the hard object to scuff the screen.

Please keep the LCD clean. Use the soft cloth to clean regularly. Do not use gasoline, alcohol or other chemical reagent to clean the screen.

Do not allow the LCD video standstill for a long time; it may result in permanent damage.

7. Lithium battery

Improper battery use may result in fire, explosion, or personal injury!

When replace the battery, please make sure you are using the same model!

1 Hardware Installation and Connection

Note: All the installation and operations here should conform to your local electric safety rules.

1.1 Check Unpacked Combo DVR

When you receive the combo DVR from the forwarding agent, please check whether there is any visible damage. The protective materials used for the package of the combo DVR can protect most accidental clashes during transportation. Then you can open the box to check the accessories.

Please check the items in accordance with the list on the warranty card. Finally you can remove the protective film of the combo DVR.

Note

Remote control is not a standard accessory and it is not included in the accessory bag.

1.2 About Front Panel and Rear Panel

The model in the front panel is very important; please check according to your purchase order. The label in the rear panel is very important too. Usually we need you to represent the serial number when we provide the service after sales.

1.3 Device Installation

The series product supports two installation modes: desktop/ wall-mount. The default installation is the desktop type. Please refer to the following figure. See Figure 1-1.

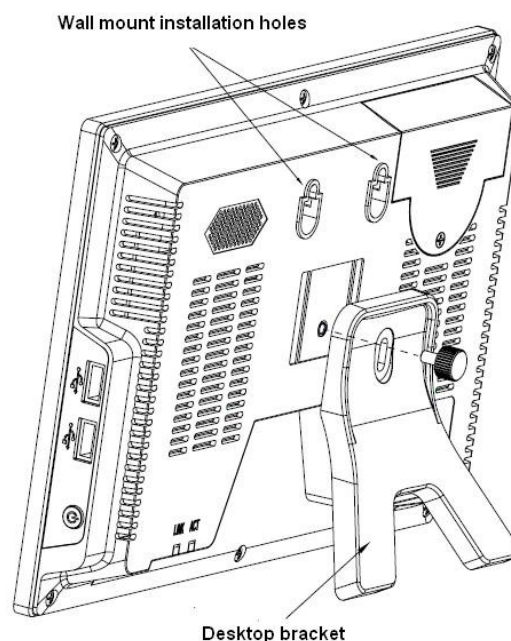

Figure 1-1

1.4 Data Cable Connection

You can refer to the following figure for cable connection. See Figure 1-2.

Please use the screwdriver to secure the data cable and the combo DVR cable socket. Please make sure it is firm otherwise it may result in network problem and etc. Then you can use the Ping command to test the network cable connection status. You need to check the cable connection if the request time is out.

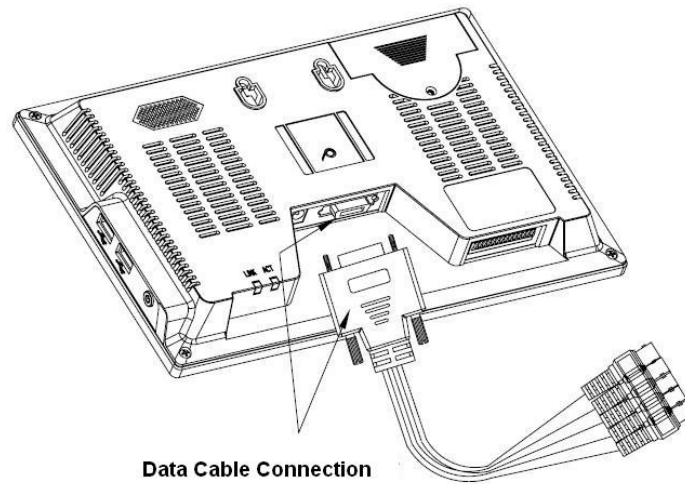

Figure 1-2

1.5 HDD Installation

This series 10.2-inch combo DVR has only one 2.5-inch SATA HDD.

You can refer to the Appendix in the user's manual for recommended HDD brand. You can select the capacity as your requirement.

Please follow the instructions below to install the HDD.

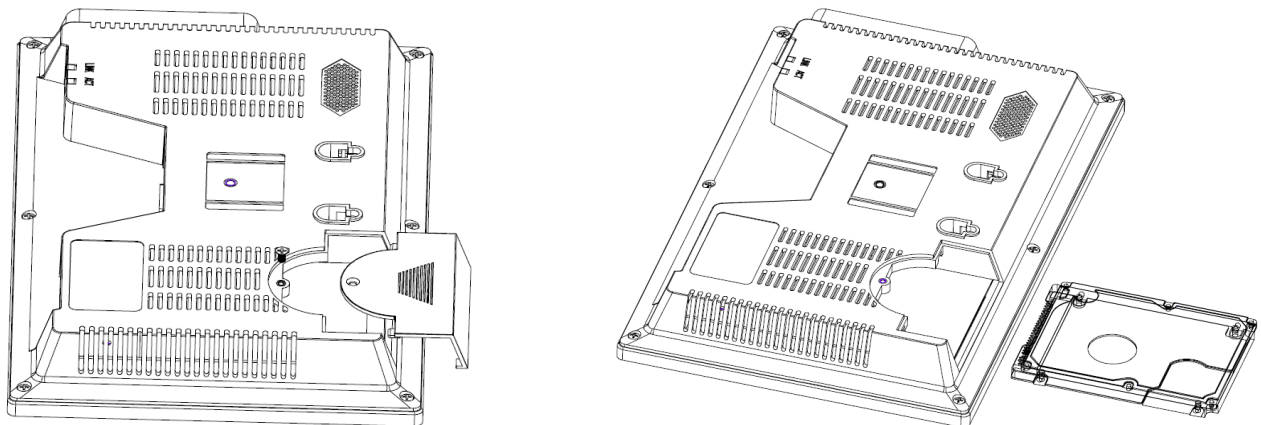

1. Turn the screw of the HDD cover and then remove the HDD cover

2. Line up the HDD to the HDD slot and then install

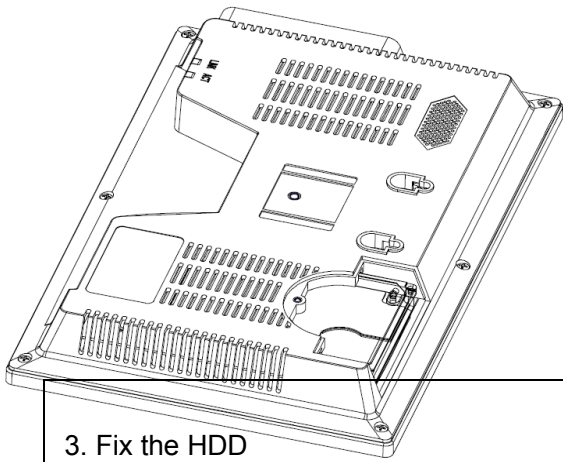

3. Fix the HDD

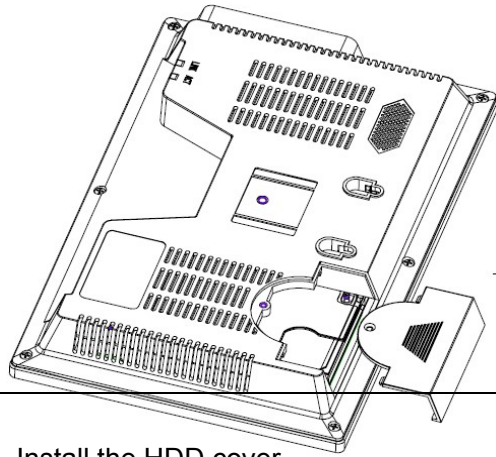

4. Install the HDD cover.

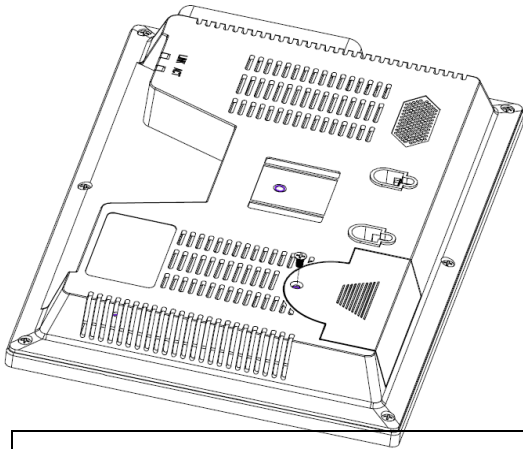

5. Secure the screw of the HDD cover.

Now the installation completed

1.6 Dimensions

You can refer to the following two figures for dimension information. See Figure 1-3 and Figure 1-4.

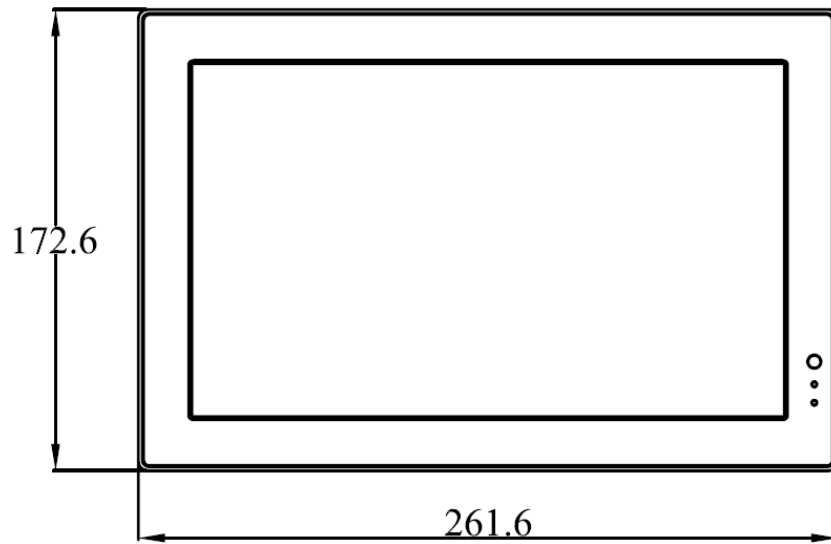

Figure 1-3

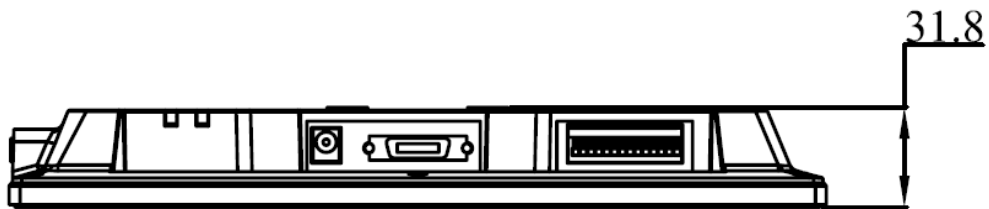

Figure 1-4

1.7 Front Panel, Side Panel and Rear Panel

The front panel and side panel is shown as in Figure 1-5.

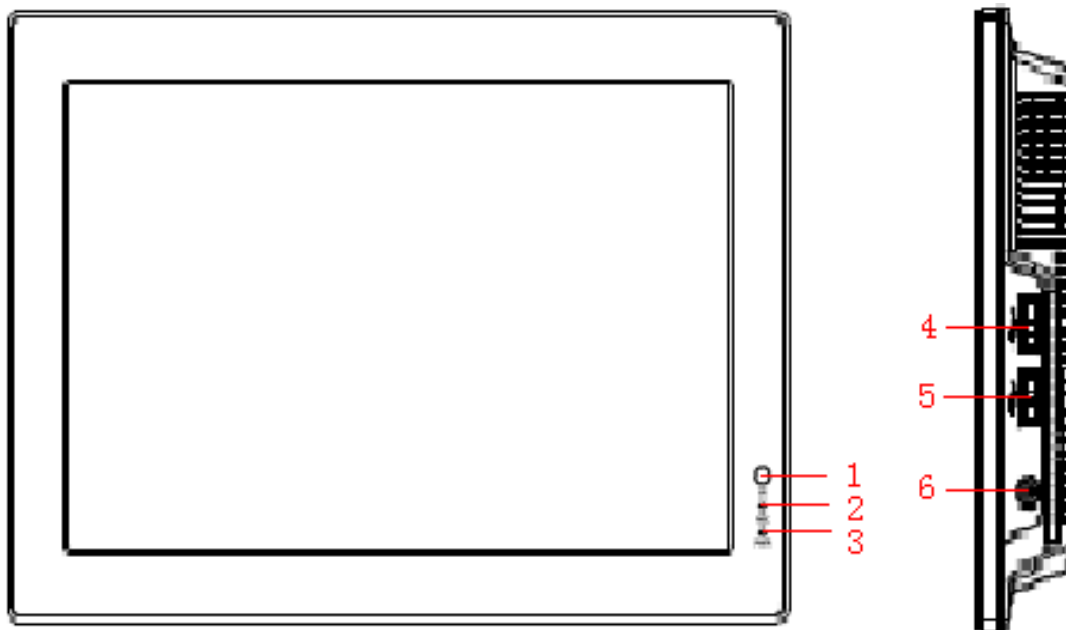

Figure 1-5

The rear panel is shown as below. See Figure 1-6.

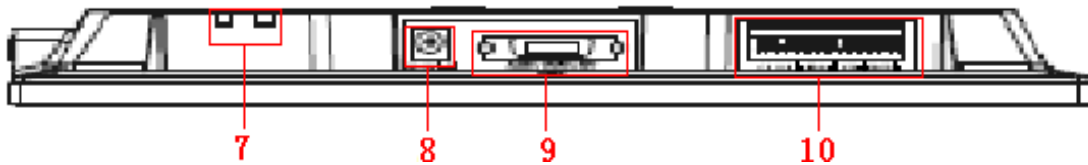

Figure 1-6

Please refer to the following sheet for front panel button information.

SN	Name	Function
1	Remote control signal receive window.	It is to receive the signal from the remote control.
2	HDD indication light	The light is on when systems is reading or write the HDD data.
3	Power indication light	The light is on when the device is connected to the power.
4/5	USB port	/
6	On/off button	When the device is off, press it for a long time to boot up the device. When the device is on press it for a long time to shut down the device. When the device is off, press it for a short time to close/open the screen.
7	Network status indication light	/
8	Power socket port	Connect to DC 12V power
9	Cable port	Video CVBS input, audio CVBS input, video CVBS output, audio CVBS output, RJ45 port.
10	Power socket	Alarm input, alarm output, RJ-45 port, RS-232 port.

1.8 Connection Sample

Please refer to Figure 1-7 for connection sample.

T The following figure is based on the 8-channel series product.

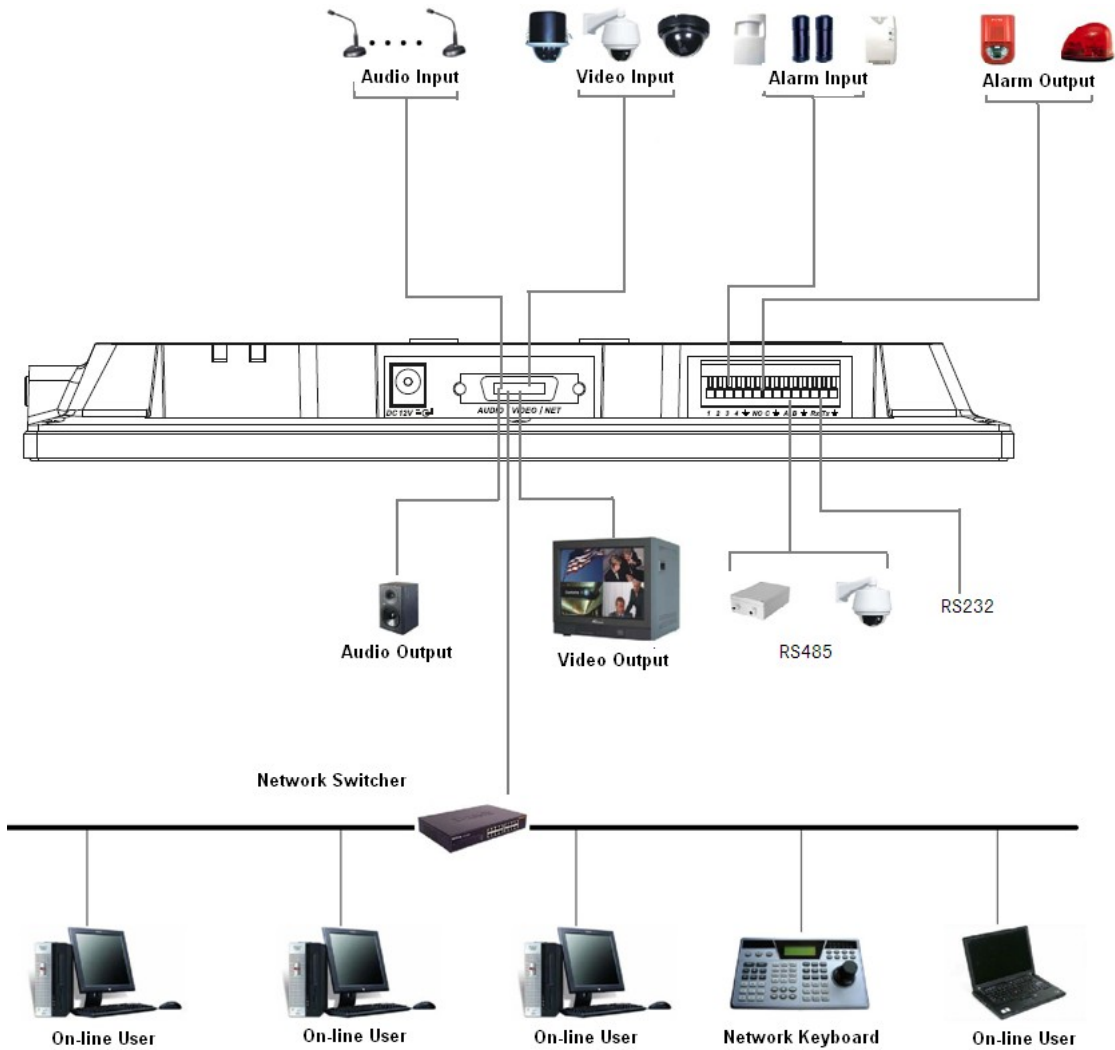

Figure 1-7

1.9 Alarm Input and Output Connection

There are two alarm input types for you to select: normal open (NO) and normal close (NC).

1.9.1 Alarm Input and Output Details

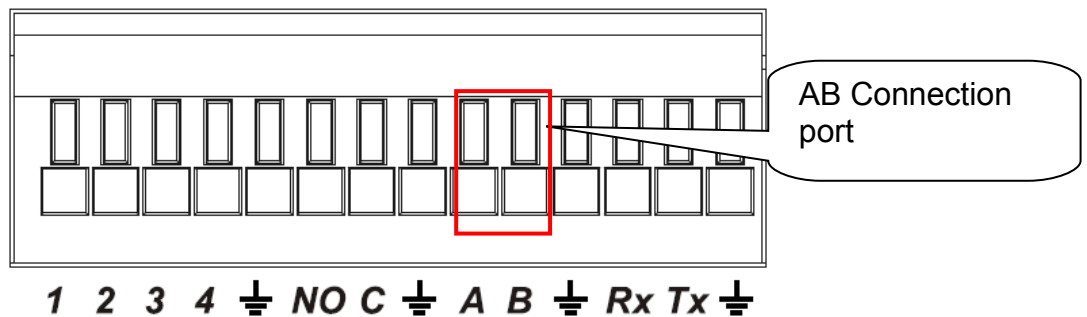



Figure 1-8

You can refer to the following sheet and Figure 1-8 for alarm input and output information.

Parameter	Grounding Alarm
-----------	-----------------

	Ground line
1, 2, 3, 4.	Alarm input 1 to alarm input 4. It becomes valid in low voltage.
NO C	A group of normal open activation output.
Rx,TX	It is RS232 port to connect to the COM (debug), keyboard port and transparent port (transfer COM input and output via the network).
A/B	RS485 communication port. They are used to control devices such as PTZ. Please parallel connect 120Ω between A/B cables if there are too many PTZ decoders.

1.9.2 Alarm Input Port

Please refer to the following sheet for more information.

- 4-channel alarm input. Normal open or Normal close type.
- Please parallel connect COM end and GND end of the alarm detector (Provide external power to the alarm detector).
- Please parallel connect the Ground of the combo DVR and the ground of the alarm detector.
- Please connect the NC port of the alarm sensor to the combo DVR alarm input(ALARM)
- Use the same ground with that of combo DVR if you use external power to the alarm device.

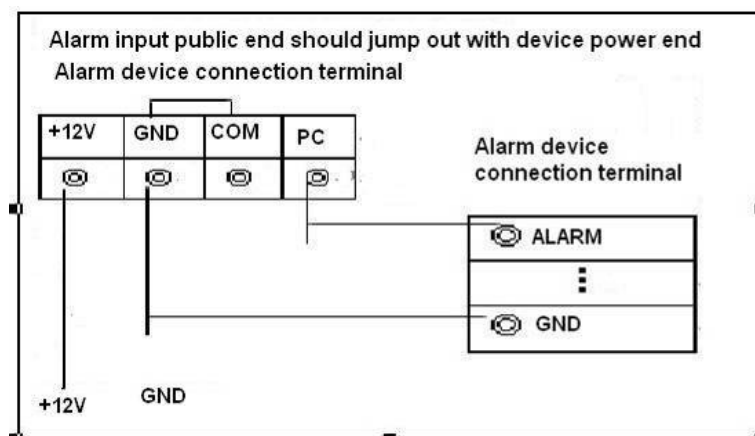

Figure 1-9

1.9.3 Alarm Output Port

- 1-channel relay alarm output (NO contact). Provide external power to external alarm device.
- To avoid overloading, please read relay parameters sheet in the *User's Manual* carefully.
- RS485 A/B cable is for the A/B cable of the PTZ decoder.

2 Overview of Navigation and Controls

Before operation, please make sure you have properly installed HDDs and all the cable connections.

2.1 Login, Logout & Main Menu

2.1.1 Login

After system booted up, default video display is in multiple-window mode.

Click Enter or left click mouse, you can see the login interface. See Figure 2-10.

System consists of four accounts:

- **Username:** admin. **Password:** admin. (administrator, local and network)
- **Username:** 888888. **Password:** 888888. (administrator, local only)
- **Username:** 666666. **Passwords:** 666666(Lower authority user who can only monitor, playback, backup and etc.)
- Username: default. Password: default(hidden user)

You can use USB mouse, front panel, remote control (not included in the accessory bag) or

keyboard to input. About input method: Click **123** to switch between numeral, English character (small/capitalized) and denotation.

Note:

For security reason, please modify password after you first login.

Within 30 minutes, three times login failure will result in system alarm and five times login failure will result in account lock!



Figure 2-10

2.1.2 Main Menu

After you logged in, the system main menu is shown as below. See Figure 2-11.

There are total six icons: search, information, setting, backup, advanced and shutdown.

You can move the cursor to highlight the icon, and then double click mouse to enter the sub-menu.

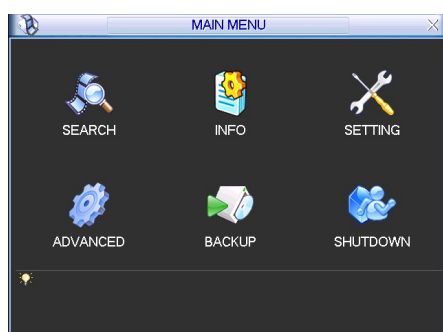

Figure 2-11

2.1.3 Shutdown

Important

Please open the HDD cover and then cut off the power before you replace the HDD!

There are two ways for you to shutdown the device.

The first one is from menu option (**recommended**):

In the main menu, click shutdown button, you can see an interface is shown as below. See Figure 2-12.



Figure 2-12

There are several options for you. See Figure 2-13.

Please select the shutdown item to turn off the combo DVR.

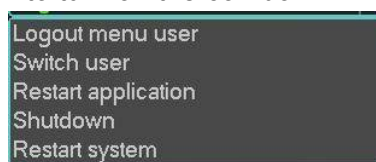

Figure 2-13

The other way is to press power button on the side panel to turn off the device.

2.1.4 Auto Resume after Power Failure

The system can automatically backup video and resume previous working status after power failure.

2.1.5 Replace Button Battery

Please make sure to use the same battery model if possible.





Please contact your local retailer before you replace the battery.

We recommend replace battery regularly (such as one-year) to guarantee system time accuracy.

Before replacement, please save the system setup, otherwise, you may lose the data completely!

2.2 Live Viewing

After you logged in, the system is in live viewing mode by default. You can see system date, time and channel name. If you want to change system date and time, you can refer to general settings (Main Menu->Setting->General). If you want to modify the channel name, please refer to the display settings (Main Menu->Setting->Display)

1		Recording status	3		Video loss
2		Motion detection	4		Camera lock

2.3 Schedule

Note:

You need to have proper rights to implement the following operations. Please make sure the HDDs have been properly installed.

After the system booted up, it is in default 24-hour regular mode. You can set record type and time in schedule interface.

In the main menu, from Setting to Schedule, you can go to schedule menu. See Figure 2-14. There are total six periods.

- Channel: Please select the channel number first. You can select “all” if you want to set for the whole channels.
- Week day: There are eight options: ranges from Saturday to Sunday and all.
- Pre-record: System can pre-record the video before the event occurs into the file. The value ranges from 1 to 30 seconds depending on the bit stream.
- Snapshot: You can enable this function to snapshot image when alarm occurs. (**Note:** This function is for 4-channel series only. The 8-channel series product does not support the schedule snapshot function.)
- Record types: There are four types: regular, motion detection (MD), Alarm, MD & alarm.

Please highlight icon  to select the corresponding function. After completing all the setups please click save button, system goes back to the previous menu.

At the bottom of the menu, there are color bars for your reference. Green color stands for regular recording, yellow color stands for motion detection and red color stands for alarm recording. The white means the MD and alarm record is valid. Once you have set to record when the MD and alarm occurs, system will not record neither motion detect occurs nor the alarm occurs.



Figure 2-14

2.4 Manual Record

Note:

Please make sure you have the record operation right and you have properly installed the formatted HDD.

You can right click mouse or in the main menu, from Advanced->Manual Record to go to record interface.

There are three statuses: schedule/manual/stop. Highlight icon“o” to select corresponding channel. See Figure 2-15.

- Manual: The highest priority. After manual setup, all selected channels will begin ordinary recording.
- Schedule: Channel records as you have set in recording setup (Main Menu->Setting->Schedule)
- Stop: All channels stop recording.



Figure 2-15

2.5 Encode

Encode interface is shown as in Figure 2-16.

- Channel: Select the channel you want.
- Compression: System supports H.264.
- Resolution: System supports various resolutions, you can select from the dropdown list. For this model, main stream supports D1/CIF/QCIF. Please note the resolution may vary due to different channels. The extra stream supports QCIF only.
- Frame rate: It ranges from 1f/s to 25f/s in NTSC mode and 1f/s to 30f/s in PAL mode.

Note:

For the 8-ch series 10.2-inch combo DVR, the 1-channel resolution is D1 (PAL: 25f/s. NTSC 30f/s)/CIF/QCIF. The rest seven channels (channel 2 to channel 7) support D1 (PAL: 6f/s. NTSC: 7f/s)/CIF/QCIF.

- Bit rate type: system supports two types: CBR and VBR. In VBR mode, you can set video quality.
- Quality: There are six levels ranging from 1 to 6. The sixth level has the highest image quality.
- Video/audio: you can enable or disable the video/audio. Please note the video is enabled for main stream by default. For extra stream, please enable video first and then enable audio.
- Snapshot: Click snapshot button, you can see it contains the four items: mode/image size/image quality/snapshot frequency. Please refer to chapter 2.3.3 for detail information.

Please highlight icon  to select the corresponding function.

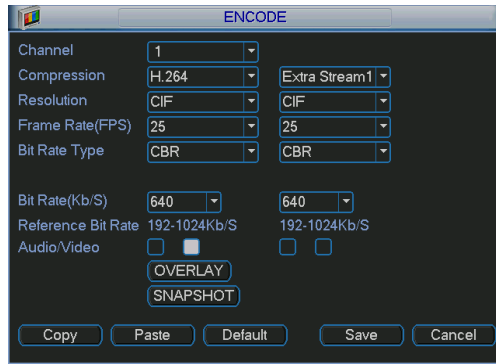

Figure 2-16

2.5.1 Snapshot

2.5.1.1 Schedule Snapshot

Note: This function is for 4-channel series only.

In Encode interface, click snapshot button to input snapshot mode, size, quality and frequency.

In General interface please input upload interval.

In Schedule interface, please enable snapshot function.

Please refer to the following figure for detail information. See Figure 2-8.

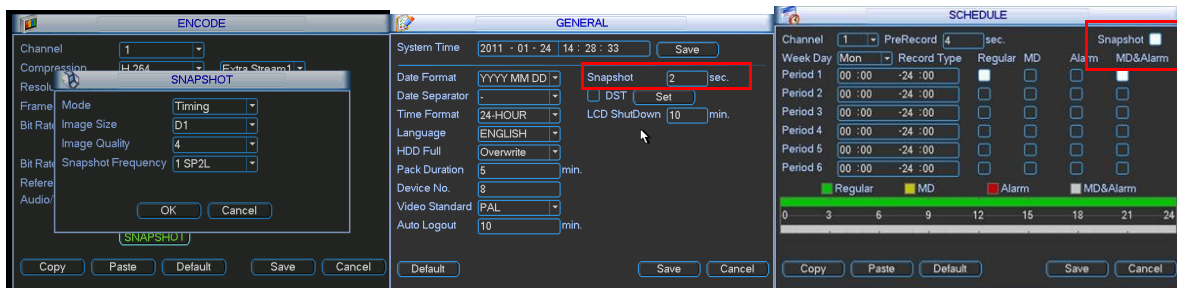

Figure 2-17

2.5.1.2 Activation Snapshot

Please follow the steps listed below to enable the activation snapshot function. After you enabled this function, system can snapshot when the corresponding alarm occurred.

- In Encode interface, click snapshot button to input snapshot mode, size, quality and frequency.
- In General interface please input upload interval.
- In Detect interface please enable snapshot function for specified channels. Or in Alarm interface please enable snapshot function for specified channels.

Please refer to the following figure for detail information. See Figure 2-9.

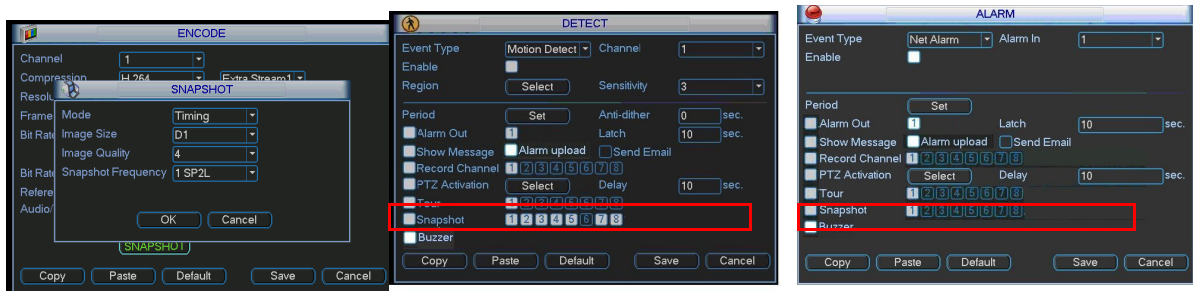

Figure 2-18

2.5.1.3 Priority

Please note the activation snapshot has the higher priority than schedule snapshot. If you have enabled these two types at the same time, system can activate the activation snapshot when alarm occurs, and otherwise system just operates the schedule snapshot.

2.5.2 Image FTP

In Network interface, you can set FTP server information. Please enable FTP function and then click save button. See Figure 2-10. Please refer to the *User's Manual* included in the resource CD for detailed information.

Please boot up corresponding FTP server.

Please enable schedule snapshot or activation snapshot (Chapter 2.3.3) and then system can upload the image file to the FTP server.

Type	Record FTP	
Server IP	0 . 0 . 0 . 0	Port 1024
Alternate IP	0 . 0 . 0 . 0	
User Name		
Password	<input type="checkbox"/> Anonymous	
Remote Directory	File Length 0 M	
Channel	1	
Weekday	Tue	Alarm Motion General
Time Period 1	00 :00 -24 :00	<input type="checkbox"/> <input type="checkbox"/> <input type="checkbox"/>
Time Period 2	00 :00 -24 :00	<input type="checkbox"/> <input type="checkbox"/> <input type="checkbox"/>

Please input the corresponding information here, if you just upload the image FTP.

Figure 2-19

2.6 Search and Playback

Click search button in the main menu, search interface is shown as below. See Figure 2-20.

Usually there are three file types:

- R: Regular recording file.-
- A: External alarm recording file.
- M: Motion detection recording file

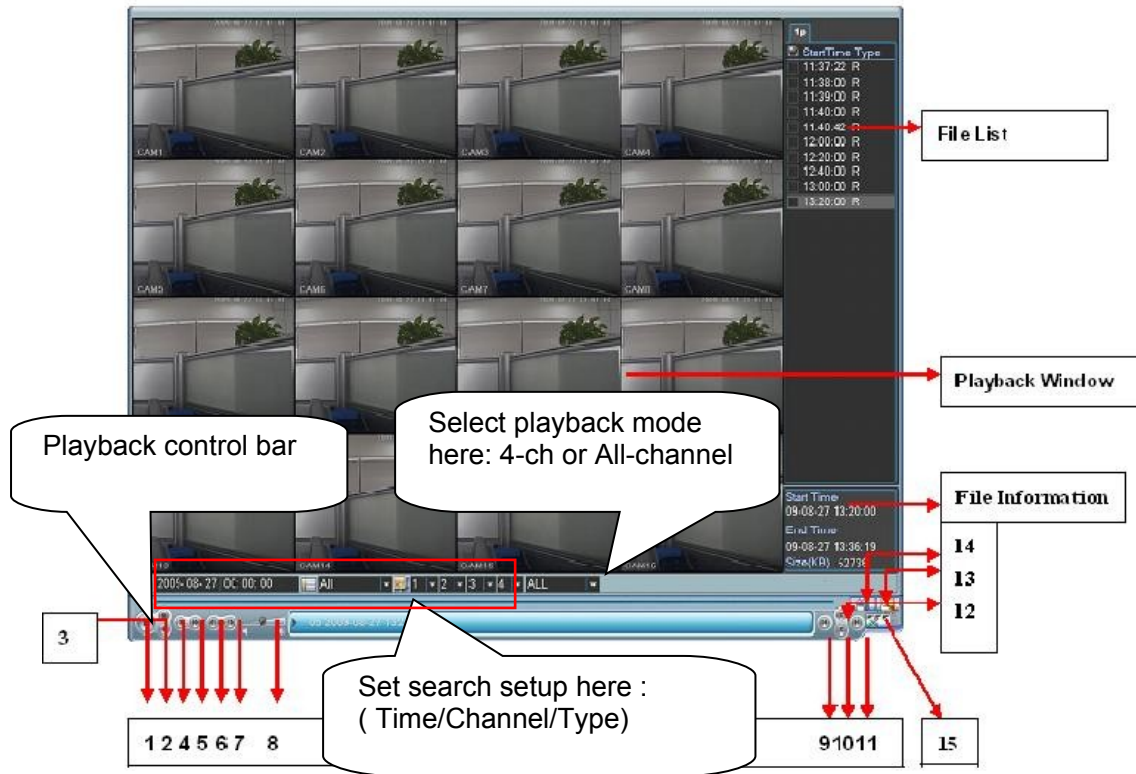

Figure 2-20

Please refer to the following sheet for more information.

Serial Number	Function
1	Play
2	Backward
3	Stop
4	Slow play
5	Fast play
6	Previous frame
7	Next frame
8	Volume
9	Previous file
10	Next channel
11	Next file
12	Previous channel
13	Search
14	Backup
15	Clip

2.6.1 Basic Operation

2.6.1.1 Playback Operation

There are various search modes: video type, channel number or time. The system can max display 128 files in one screen. You can use page up/down button to view if there are more than one page.

Select the file name and double click mouse (or click enter button), you can view file content.

2.6.1.2 Playback Mode

There are two playback modes: 4-ch and all-channel. In 4-ch playback mode, you can select the 1/2/3/4-ch playback according to your requirement. In all-channel mode, system can playback in full channels. Please note the 4-ch has no all-channel playback mode.

2.6.1.3 Accurate playback

Input time (h/m/s) in the time column and then click playback button, system can operate accurate playback.

2.6.1.4 Synchronized playback function when playback



During playback process, click numeral key, system can switch to the corresponding channel video of the same time.

2.6.1.5 Digital zoom

When the system is in full-screen playback mode, drag your mouse in the screen to select a section and then left click mouse to realize digital zoom. You can right click mouse to exit.

2.6.1.6 File backup and clip

System supports backup operation during search. You can draw a √ before file name (multiple choices). Then click backup button (Button 14 in Figure 2-20).

If you want to clip a period of file, please playback the original file first. Click the  (Button 15 in Figure 4-10) at the start point (that is your new file beginning point). Drag the file to the end point (that is your new file end point) and then click the  again. Click the backup button (Button 14 in Figure 4-10) to save your current new file.

2.6.1.7 Calendar

Click calendar icon  in Figure 2-11, system pops up a calendar for your reference.

The highlighted date means there are record files in that day. You can click blue date to view file list.

In the following interface you can see there are video files in June 13th and 14th. Double click the date to view file list.



Figure 2-21

2.6.1.8 Slow playback and fast playback

Please refer to the following sheet for slow play and fast playback function.

Button	Illustration	Remarks
Fast play button ►►	In playback mode, click this button to switch between various fast play modes such as fast play 1, fast play 2 and more.	Frame rate may vary due to different versions.

Slow play button ►	In playback mode, click this button to switch between various slow play modes such as slow play 1 or slow play 2.	
Play/Pause ►	In slow playback mode, click this button to switch between play/pause modes.	
Previous/next	In playback mode, you can click ◀ and ▶ to view previous or next video in current channel.	

2.6.1.9 Backward playback and frame by frame playback

Button	Illustration	Remarks
Backward play: ◀ in playback interface.	In normal playback mode, left click backward play button◀, system begins backward playback. Double click backward play button again, system goes to pause mode.	When system is in backward play or frame by frame playback mode, you can click play button► / to go to normal playback.
Manual playback frame by frame.	Click pause button in normal playback mode, you can use ◀ and ▶ to view frame by frame.	

Note:

All the operations here (such as playback speed, channel, time and progress) have relationship with hardware version. Some series combo DVRs do not support some functions or playback speeds.

2.7 Network Setup

Here is for you to input network information. See Figure 2-22.

- IP address: Here you can input IP address.
- DHCP: It is auto search IP function. When enable DHCP function, you can not modify IP/Subnet mask /Gateway. These values are from DHCP function. If you have not enabled DHCP function, IP/Subnet mask/Gateway display as 0. You need to disable DHCP function to view current IP information. Besides, when PPPoE is operating, you can not modify IP/Subnet mask /Gateway.
- TCP port: Default value is 37777.
- UDP port: Default value is 37778.
- HTTP port: Default value is 80.
- Max connection: system support maximal 10 users. 0 means there is no connection limit.
- Transfer mode: Here you can select the priority between fluency/video qualities.
- Network download: System can process the downloaded data first if you enable this function.
- Advanced setting: Please refer to the *user's manual* included in the resource CD for detail information.

After completing all the setups please click save button, system goes back to the previous menu.

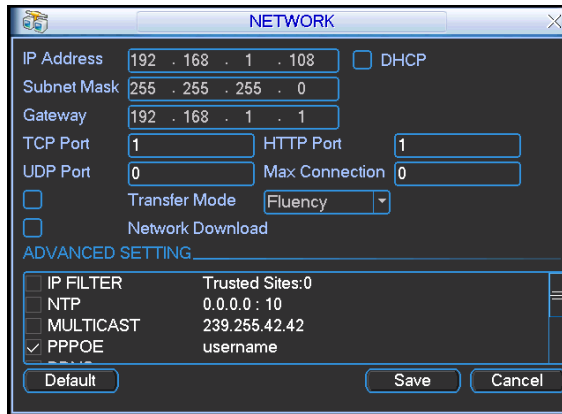

Figure 2-22

2.8 Pan/Tilt/Zoom

Please note:

- Slight difference may be found in the user's interface, due to various protocols.
- Please make sure the speed domes A/B cables are properly connected to the A/B ports of combo DVR.
- You have properly set PTZ information.
- Please switch camera monitor channel to current window.

2.8.1 PTZ Setup

The pan/tilt/zoom setup includes the following items. Please select channel first. See Figure 2-23.

- Protocol: Select corresponding PTZ protocol such as PELCOD.
- Address: Input corresponding PTZ address.
- Baud rate: Select baud rate.
- Data bit: Select data bit. Default value is 8.
- Stop bit: Select stop bit. Default value is 1.
- Parity: There are three choices: none/odd/even. Default value is none.

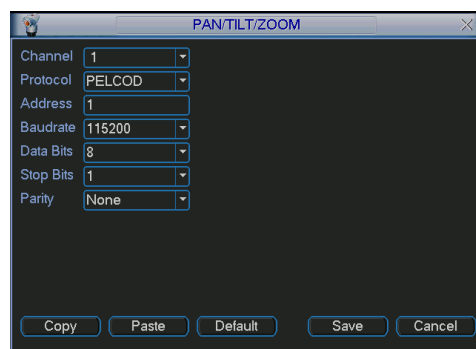

Figure 2-23

After completing all the setups please click save button, system goes back to the previous menu.

2.8.2 PTZ Operation

In one window display mode, right click mouse (click "Fn" Button in the front panel or click "Fn" key in the remote control). The interface is shown as in Figure 2-24.

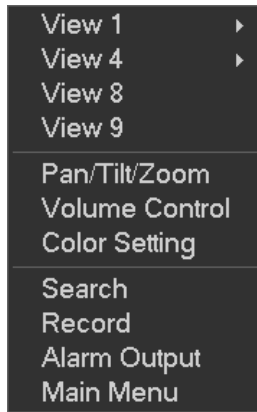

Figure 2-24

Click Pan/Tilt/Zoom, the interface is shown as below. See Figure 2-25.

Here you can set the following items:

- Step: value ranges from 1 to 8.
- Zoom
- Focus
- Iris



Click icon  and  to adjust zoom, focus and iris.



Figure 2-25

In Figure 2-25, please click direction arrows (See Figure 2-26) to adjust PTZ position. There are total 8 direction arrows. Please note if you use remote control, you can use just four directions (Up/down/left/right).

The speed value ranges from 1 to 8.



Figure 2-26

2.8.3 3D Intelligent Positioning Key













In the middle of the eight direction arrows, there is a 3D intelligent positioning key. See Figure 2-27. Please note, this function needs protocol supported and can only be operated by mouse.

Click this key, system goes back to the single screen mode. Drag the mouse in the screen to adjust section size. It can realize PTZ automatically.



Figure 2-27

Here is a sheet for you reference.

Name	Function key	function	Shortcut key	Function key	function	Shortcut Key
Zoom		Near			Far	
Focus		Near			Far	
Iris		close			Open	

You can click set button in Figure 2-25 (or click REC button in the front panel) to set preset, tour, and pattern.

You can click page switch button in Figure 2-25 (or click Fn button in the front panel) to call main function.

3 Web Operation

Slightly difference may be found in the interface due to different series.
The following operation is based on the 8-channel series product.

3.1 Network Connection

Before web client operation, please check the following items:

- Network connection is right
- Combo DVR and PC network setup is right. Please refer to network setup(main menu->setting->network)
- Use order ping *****.***.***.*****(* combo DVR IP address) to check connection is OK or not. Usually the return TTL value should be less than 255.
- System can automatically download latest web control and the new version can overwrite the previous one.
- If you want to un-install the web controls, please run *uninstall webrec2.0.bat* to auto delete the control or you can go to C:\Program Files\webrec to delete Single folder.

3.2 Login

Open IE and input combo DVR address in the address column. For example, if your combo DVR IP is 10.10.3.16, then please input **http:// 10.10.3.16** in IE address column.

System pops up warning information to ask you whether install webrec.cab control or not. Please click yes button.

If you can't download the ActiveX file, please modify your IE security setup.

After installation, the interface is shown as below. See Figure 3-28.

Please input your user name and password.

Default factory name is admin and password is admin.

Note: For security reasons, please modify your password after you first login.

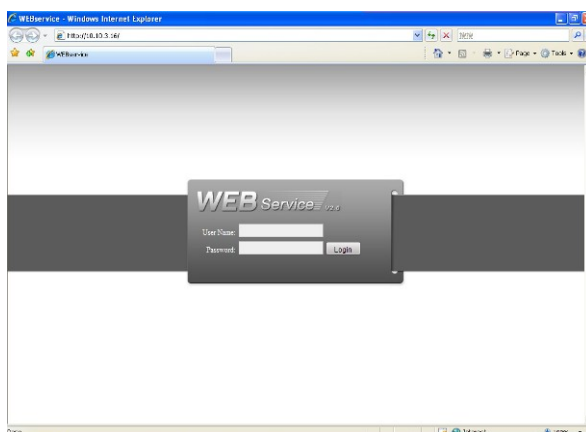

Figure 3-28

3.3 Main Window

After you logged in, you can see the main window. See Figure 3-29.

Click the channel name on the left side; you can view the real-time video.

For detailed operation information, please refer to the *User's Manual* included in the resources CD.

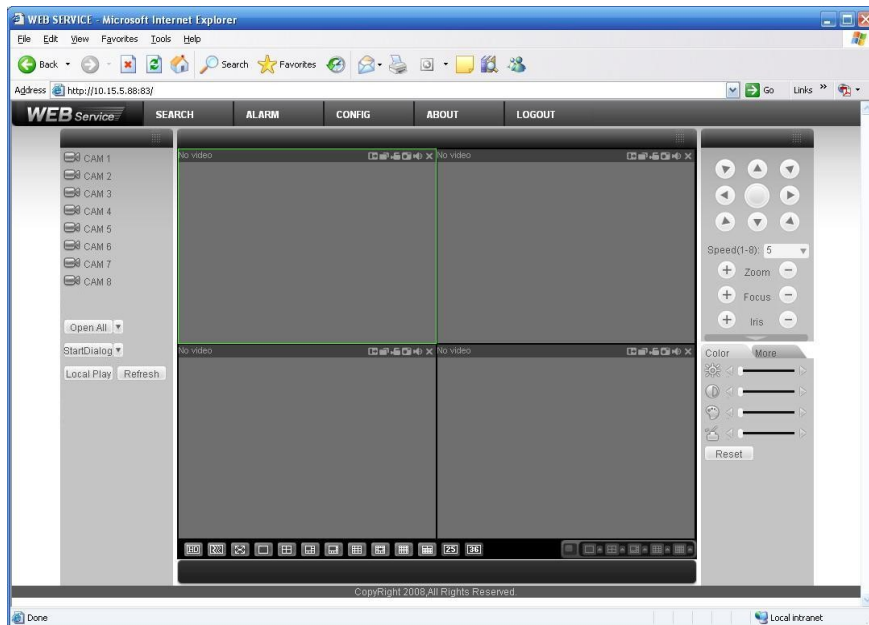

Figure 3-29

Note

- For detailed operation introduction, please refer to our resource CD included in your package for electronic version of the *User's Manual*.
- Slight difference may be found in user interface.
- All the designs and software here are subject to change without prior written notice.
- If there is any uncertainty or controversy, please refer to the final explanation of us.
- Please visit our website for more information.