

# **Network Keyboard Operating Manual**

# Contents

|   |    |
|---|----|
| Welcome.....  | 4  |
| Important Safeguarding and Warnings.....                | 5  |
| 1 Feature and Specification.....                        | 6  |
| 1.1 Feature.....  | 6  |
| 1.2 Specification.....                                  | 6  |
| 2 Keyboard Function.....                                | 7  |
| 2.1 Keyboard Appearance.....                            | 7  |
| 2.2 Key Function List.....                              | 7  |
| 2.3 Keyboard Ports.....                                 | 10 |
| 2.4 Port Features.....                                  | 10 |
| 2.5 Power.....  | 10 |
| 3 Menu Tree.....  | 12 |
| 3.1 Input Method.....                                   | 13 |
| 3.2 Log In.....   | 13 |
| 3.3 Log out.....  | 13 |
| 4 Menu Operation.....                                   | 14 |
| 4.1 Local Setup.....                                    | 14 |
| 4.1.1 Network Setup.....                                | 14 |
| 4.1.2 Time Setup.....                                   | 14 |
| 4.1.3 Address Setup.....                                | 14 |
| 4.2 CTL Point.....                                      | 15 |
| 4.2.1 ID.....   | 15 |
| 4.2.2 Device Name.....                                  | 15 |
| 4.2.3 Device Type.....                                  | 15 |
| 4.2.4 Connection Type.....                              | 15 |
| 4.3 Advance.....  | 16 |
| 4.3.1 Password.....                                     | 16 |
| 4.3.2 User Management.....                              | 16 |
| 4.3.3 Set Local as Default.....                         | 17 |
| 4.3.4 Empty Control Point.....                          | 18 |
| 4.4 Assistant Setup.....                                | 18 |
| 4.4.1 Backlight Setup.....                              | 18 |
| 4.4.2 Alarm Setup.....                                  | 18 |
| 4.4.3 Language.....                                     | 18 |
| 4.4.4 Auto Lock.....                                    | 18 |
| 4.5 System Information.....                             | 18 |
| 4.5.1 Search Point.....                                 | 18 |
| 5 Keyboard Control DVR.....                             | 20 |
| 5.1 Serial Port Connection.....                         | 20 |
| 5.1.1 RS232 Serial Port Connection.....                 | 20 |
| 5.1.2 Via RS485 Connection.....                         | 20 |
| 5.1.3 Multi-keyboard Level-link via RS485.....          | 21 |
| 5.2 Network Connection (For Network Keyboard Only)..... | 21 |
| 5.2.1 RJ45 port connection.....                         | 22 |

|       |  |    |
|-------|--|----|
| 5.3   | DVR and Keyboard Setup .....                     | 22 |
| 5.3.1 | DVR Setup.....                                   | 22 |
| 5.3.2 | Keyboard Setup after Serial Port Connection..... | 23 |
| 5.3.3 | Keyboard Setup after Network Connection.....     | 24 |
| 5.4   | Operation .....                                  | 24 |
| 5.4.1 | Login.....                                       | 24 |
| 5.4.2 | Logout .....                                     | 24 |
| 5.4.3 | Record.....                                      | 24 |
| 5.4.4 | PTZ Control and Image Color .....                | 25 |
| 5.4.5 | Tour and Single/Multiple Window Switch. ....     | 25 |
| 5.4.6 | Network keyboard backup (USB backup) .....       | 25 |
| 6     | Network Keyboard Control Dome .....              | 27 |
| 6.1   | Cable Connection .....                           | 27 |
| 6.2   | Keyboard Setup .....                             | 27 |
| 6.3   | Operation .....                                  | 27 |
| 6.3.1 | Direction Setup .....                            | 28 |
| 6.3.2 | Preset.....                                      | 28 |
| 6.3.3 | Scan .....                                       | 28 |
| 6.3.4 | Tour .....                                       | 29 |
| 6.3.5 | PATTERN.....                                     | 30 |
| 6.3.6 | Pan Rotation .....                               | 30 |
| 6.3.7 | Light/Wiper/Assistant/Fan Setup .....            | 30 |
| 7     | Network Keyboard Upgrade .....                   | 31 |
| 8     | Make Serial Port.....                            | 33 |
| 8.1   | RS232 Serial Port.....                           | 33 |
| 8.2   | 485 Port.....                                    | 33 |
| 8.3   | 25-pin Port and Switch Box Connection .....      | 33 |

## **Welcome**

Thank you for purchasing our network keyboard!

This operating manual is designed to be a reference tool for the operation of your keyboard.

Here you can find information about this keyboard features and functions, as well as a detailed menu tree.

Before operation please read the following safeguards and warnings carefully!

## **Important Safeguarding and Warnings**

All installation and operation should conform to your local electrical safety codes. We assume no liability or responsibility for all the fires or electrical shock caused by improper handling or installation

All the examination and repair should be done by the qualified service engineers. We are not liable for any problems caused by unauthorized modifications or attempted repair.

# 1 Feature and Specification

## 1.1 Feature

This series keyboard has the following features

- One keyboard can control multiple DVRs, or you can use multiple keyboards to control one DVR.
- Support dome operation.
- Support RS485 port and RS232 port.
- Support PTZ operation via joystick
- Support all operations you get from DVR front panel function keys
- Support keyboard lock function
- Support multiple-level operation rights
- Support level-link
- Support single or multiple DVRs's menu setup
- On-screen menu, user-friendly procedure. It is very easy for you to operate
- Can control network video server and network video decoder
- Support network ports connection
- Receive DVR alarm information, support one-channel activation on alarm,
- USB port support network backup DVR video data.

## 1.2 Specification

|                            |  |
|----------------------------|--|
| <b>Working Temperature</b> | 0°C-+55°C  |
| <b>Weight</b>              | 2. 5Kg   |
| <b>Dimension</b>           | 320mmx190mmx50mm<br>(Includes joystick height 100mm) |
| <b>Working Power</b>       | 12VDC 1200mA   |
| <b>LCD Dimension</b>       | 84mm x 31 mm   |

## 2 Keyboard Function

### 2.1 Keyboard Appearance

Keyboard is shown as in Figure 2-1.

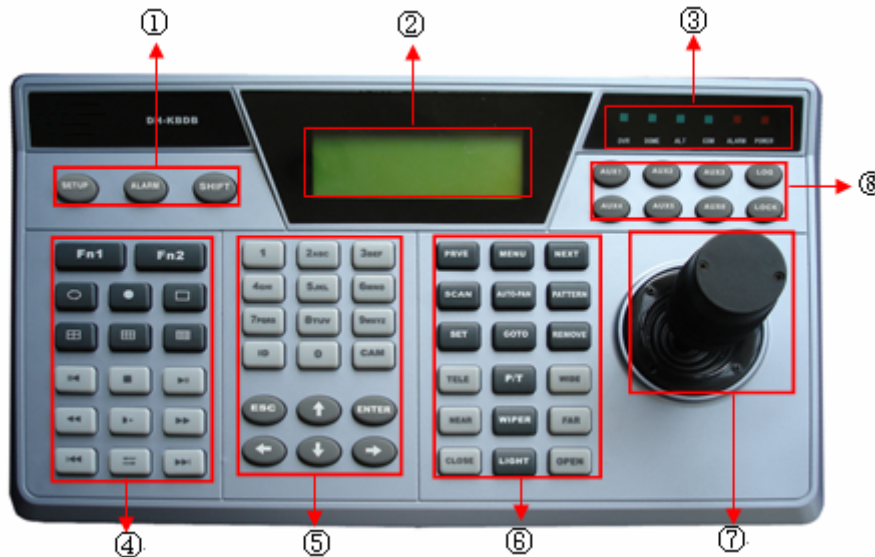

Figure 2-1

- ① Function key: There are three function keys: SETUP/ALARM/SHIFT
- ② LCD: Here is to display on-screen menu.
- ③ Indication light: There are six indication lights. DVR/DOME/ALT/COM/ALARM/POWER.
- ④ DVR function: Here are operation keys for you to control DVR.
- ⑤ Public function: Here includes ten numeral keys, four direction keys, ESC/ENTER and ID/CAM.
- ⑥ Dome matrix function: Here are operation keys for you to control dome or matrix.
- ⑦ Joystick
- ⑧ Assistant function: from AUX1 to AUX 6, log and lock key.

### 2.2 Key Function List

| Serial numb      | Name                     | Symbol | Function                                  |
|------------------|--------------------------|--------|---|
| Function key     | Setup                    | SETUP  | Shortcut key to enter function setup menu |
|                  | Alarm                    | ALARM  | Shortcut key to enter alarm setup menu    |
|                  | Shift                    | SHIFT  | Switch between input methods              |
| LCD              | Liquid crystal displayer |        | Display on-screen menu                    |
| Indication light | DVR indication light     | DVR    | Light turns on when connected with DVR    |
|                  | Dome indication light    | DOME   | Light turns on when connected with dome   |

|                  |                              |                        |   |
|------------------|------------------------------|------------------------|---|
|                  | Other indication light       | ALT                    | Light turns on when connected with other device                                   |
|                  | Serial port indication light | COM                    | Light turns on when connected with serial port device                             |
|                  | Alarm indication light       | ALARM                  | Light turns on when connected with alarm devices                                  |
|                  | Power indication light       | POWER                  | Light turns on when keyboard connected with power and works properly.             |
| DVR function key | Assistant function key       | Fn1                    | In single surveillance mode, click Fn1 to display PTZ and image color setup menu. |
|                  |                              |                        | In motion detection setup, working with other keys                                |
|                  |                              |                        | When playback, click Fn1 to display or hide process bar.                          |
|                  | DVR assistant function key 2 | Fn2                    | In DVR menu, click Fn2 to select an input method.                                 |
|                  | Tour                         | ↻                      | Activate tour function  |
|                  | Single window display mode   | □                      | Single window display mode  |
|                  | Four window display mode     | 田                      | Turn to four window display mode  |
|                  | Nine window display mode     | 田田                     | Turn to nine window display mode  |
|                  | Sixteen window display mode  | 田田田                    | Turn to sixteen window display mode   |
|                  | Record                       | ●                      | Record/play   |
|                  | Backward /Pause              | ⏮ / ⏪                  | Video backward play or pause  |
|                  | Play frame by frame          | →                      | Play video frame by frame   |
|                  | Play /Pause                  | ▶                      | Play/pause  |
|                  |                              |                        | When DVR is in real-time surveillance mode, system goes to video search menu,.    |
| Fast             | ⏮                            | Fast backward playback |   |

|                           |                             |  |  |
|---------------------------|-----------------------------|--|--|
|                           | backward                    |  |  |
|                           | Slow play                   | ▶  | Various slow play speeds   |
|                           | Fast forward                | ▶▶   | Various fast play speeds   |
|                           | Previous                    | ◀◀   | Play the previous video  |
|                           | Next                        | ▶▶   | Play next video  |
|                           | Reverse play frame by frame | ←  | Reverse play frame by frame  |
| Public function           | Character and numerals      | 0-9  | Switch between numeral/characters, click Shift to switch.                      |
|                           | Device ID                   | ID   | Shortcut key to go to ID control point search                                  |
|                           | Device channel number       | CAM  | Control DVR channel.   |
|                           | Cancel                      | ESC  | Cancel current operation   |
|                           |                             |  | In playback mode, click this key to go back to dynamic surveillance mode.      |
|                           | Confirm                     | ENTER  | Confirm current operation  |
|                           | Direction keys              | ↑ up<br>↓ down   | In single surveillance mode, click up/down to switch between various channels. |
|                           |                             |  | Modify numeral   |
|                           |                             |  | Modify setup   |
|                           |                             | PTZ control switch   |  |
|                           | ← left<br>→ right           | In dynamic surveillance mode, click left/right key to switch between single window display and multiple window display mode. |  |
|                           |                             | PTZ control switch   |  |
| Dome/ Matrix key function | Previous page               | PREV   | In dome menu, working with other keys.   |
|                           | Dome menu                   | MENU   | In dome menu, click this key to enter dome menu shortcut key.                  |
|                           | Next page                   | NEXT   | In dome menu, working with other keys.   |
|                           | Scan                        | SCAN   | System pops up scan menu   |
|                           | Tour                        | AUTO-PAN   | System pops up auto tour menu  |
|                           | Pattern                     | PATTERN  | System pops up pattern menu  |
|                           | Set preset                  | SET  | System pops up preset setup menu   |
|                           | GOTO preset                 | GOTO   | System pops up go to preset menu   |
|                           | Remove preset               | REMOVE   | System pops up delete preset menu  |
|                           | Iris zoom in                | TELE   | PTZ iris zooms in  |
|                           | PTZ                         | P/T  | PTZ operation shortcut key   |
|                           | Iris zoom out               | WIDE   | PTZ iris zooms out   |
|                           | Focus zoom in               | NEAR   | PTZ focus zooms in   |
| Wiper                     | WIPER                       | Shortcut key to control dome wiper operation   |  |

|                        |                   |       |  |
|------------------------|-------------------|-------|--|
|                        | Focus zoom out    | FAR   | PTZ focus zooms out                        |
|                        | Lens zoom out     | CLOSE | PTZ lens zoom out                          |
|                        | Lens zoom in      | OPEN  | PTZ lens zoom in                           |
|                        | Light             | LIGHT | Control dome light                         |
|                        | Joystick          |       | Assistant menu and function key operation. |
| Assistant function key | AUX1-----<br>AUX6 |       | Assistant key                              |
|                        | LOG               | LOG   | Shortcut key to search log files           |
|                        | LOCK              | LOCK  | Shortcut key to lock keyboard              |

## 2.3 Keyboard Ports

Please refer to Figure 2-2 for keyboard port information.



Figure 2-2

- 1、RJ45 network port    2、USB port    3、IR  
4、RS485 port    5、RS232 port    6、Power

## 2.4 Port Features

RS232 can directly connect with DVR. The distance should be within 10m.  
RS-485 transmission distance is 1200 m (9600bps) , max 3000 m.  
In level-link mode, one RS-485 port can connect with as many as 16 keyboards.  
You can connect RJ45 with DVR and realize front device multiplex control via the central management software.

## 2.5 Power

The keyboard use +12V DC, you can use +12V adapter included in the accessories package. See Figure 2-3.



Figure 2-3

### 3 Menu Tree

Keyboard menu tree is shown as below.

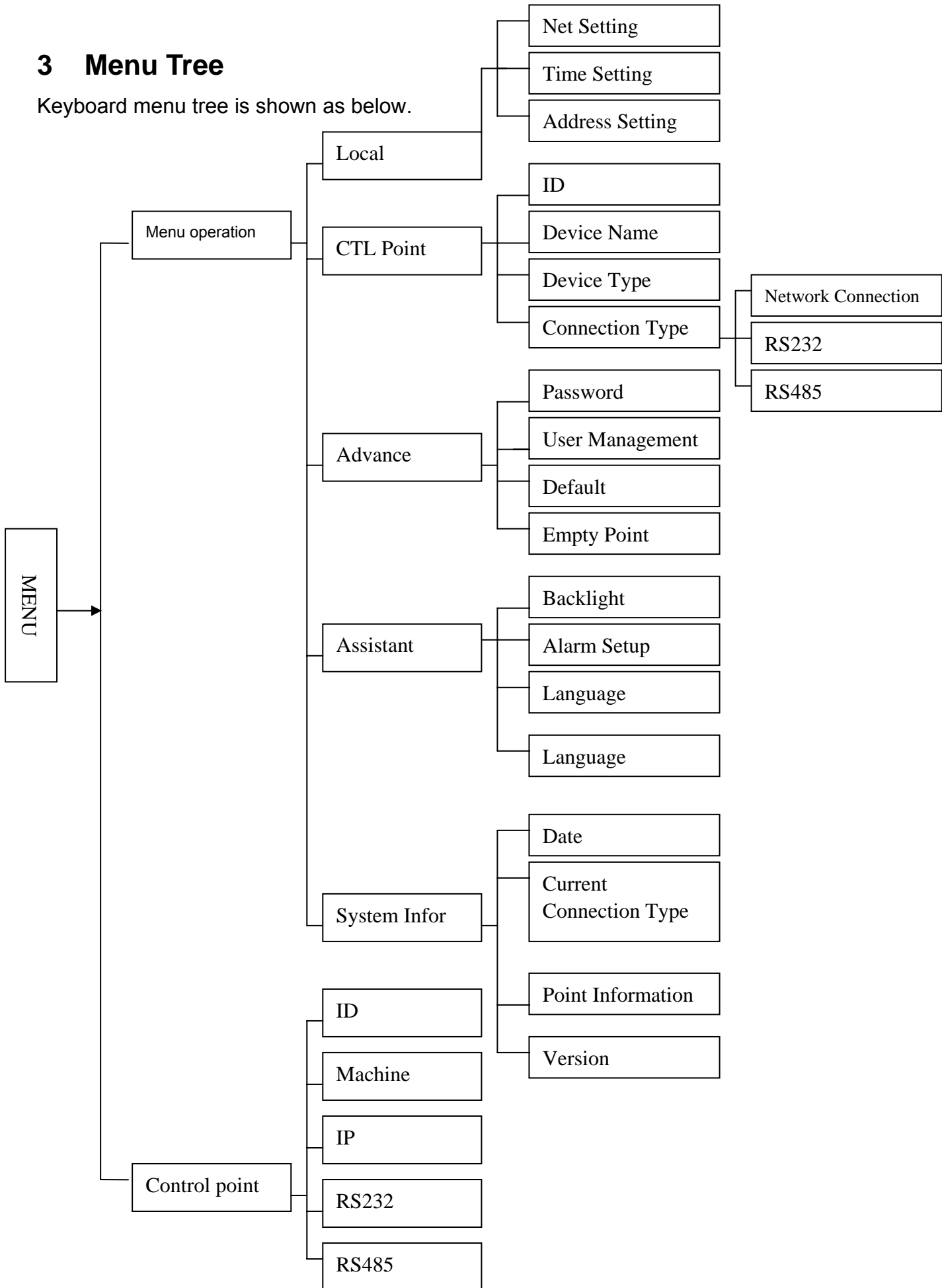

### 3.1 Input Method

Click SHIFT, you can switch between numeral/capitalized character/small character.

- ①: Numeral
- A: Capitalized character
- @ Small character.

### 3.2 Log In

Plug in power socket, power indication light is on. You can see welcome information in LCD.

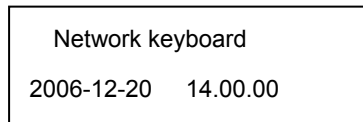

Click Enter or SETUP, system pops up a dialogue box. Now you can input user name and password.

The default user is admin, password is 888888.

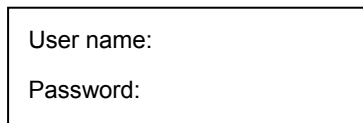
A rectangular dialog box containing two labels: "User name:" on the top line and "Password:" on the bottom line.

### 3.3 Log out

Please exit the menu and then unplug the power cable to log out.

## 4 Menu Operation

Menu operation includes five items:

- Local setup
- CTL point
- Advance
- Assistant
- System information

There are two ways for you to operate:

- Use left/right d keys to move cursor to select property and then use up/down to select other menu to set. For special menu setup please click ENTER to confirm or ESC to cancel.
- Use joystick to control. The joystick works as direction keys.

### 4.1 Local Setup

Local setup includes the following items

- Network setup
- Time setup
- Address setup

#### 4.1.1 Network Setup

Network setup is for you to input the following information.

- IP
- Sub mask
- Net gate
- Port: Default setup is 37777.

You can use left/right key to highlight corresponding item and then input numeral.

```
IP ADD: 192.168.000.118
Sub Mask: 255.255.255.000
Net Gate: 192.168.000.001
Port:: 377
```

#### 4.1.2 Time Setup

Here is for you to input local device time. Move the cursor to highlight corresponding item and then input the numeral.

```
YY: 2006 Mo: 12 DD:31
HH: 14 MI: 13 SE: 22
```

#### 4.1.3 Address Setup

Address value ranges from 0 to 255. Default factory setup is 0.

When in level-link mode, 0 has the highest priority.

```
Address setting: 0
```

## 4.2 CTL Point

CTL point includes the following items:

- ID
- Device name
- Device type
- Connection type
  - ✧ Network connection
  - ✧ RS232
  - ✧ RS485

|                        |
|------------------------|
| ID:*3                  |
| Dev name: DVR-1        |
| Dev Type: DVR          |
| Connection type: RS232 |

### 4.2.1 ID

Here is for you to input front device ID.

Move the cursor to highlight ID and then use input numeral.

If there is a \* before the ID number (such as \*3), it means that front device has control point setup.

You can view device \*3 corresponding type and name.

### 4.2.2 Device Name

Here is for you to input device name. You can use various input methods to give a name to the front device,

### 4.2.3 Device Type

There are several options: DVR/dome/matrix/NVS. You can use left/right key to select.

### 4.2.4 Connection Type

There are several options: network/RS232/RS485. You can use left/right key to select corresponding connection type.

Please refer to the following figure for more information.

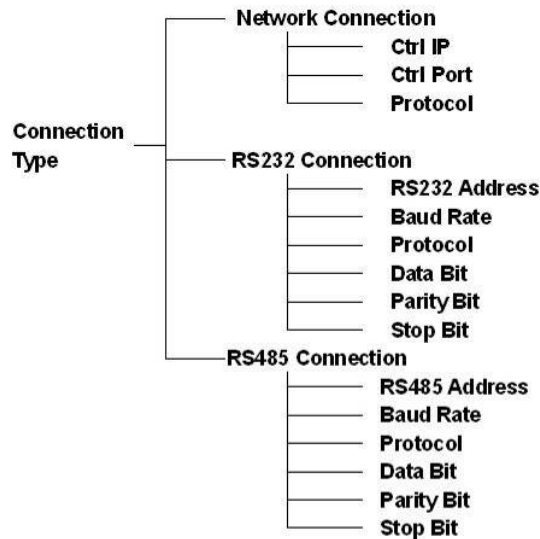

After you have selected connection type, please click ENTER to go on connection setup.

**Note:**

All the setup here should conform to you current connection type.

If your connection type setup is RS232, you front device should connect with keyboard via RS 232 port. Otherwise you can not use keyboard to control current device!

All listed items here should not leave in blank, otherwise you can not use fast search function.

After all the setup, click ESC to exit, system prompt you to save current setting.

Save current setup?  
 YES: ENTER NO: ESC

Please click ENTER to save current setup or click ESC to exit without saving current modification.

### 4.3 Advance

#### 4.3.1 Password

Here is for you to modify password.

We recommend you input a six-bit password including numeral and characters.

Administrator can modify password for all users.

Ordinary user can only modify login account password.

User: admin

Password:  ①

Confirm

#### 4.3.2 User Management

User management is for administrator only.

Administrator can add, delete or modify user, set power for each user.

Ordinary user can only modify its own password and operate all functions within power setting limit.

Guest can not operate functions. He can only review DVR video or check version information.

|               |
|---------------|
| Add user      |
| Delete user   |
| Power setting |

#### 4.3.2.1 Add User

Here is for you to add a new user. You can input new user name and password. Move the cursor to highlight Pwer, please use left key to modify user property (User/guest) and then use right key to highlight user power and click Enter to confirm. You can see there is an icon ●after your option.

- Pan ctrl
- System
- BAK
- Senior

|             |
|-------------|
| User        |
| Password    |
| Confirm     |
| Pwer:User ① |

#### 4.3.2.2 Delete user

You can select corresponding user and then click ENTER to delete.

#### 4.3.2.3 Power setting

Here you can select power for each user.

Use left and right key to highlight correspond right and click ENTER to confirm..

Icon ○ means current user does not have this right

Icon ● means current user has current right.

In the following image, current user is 1 and this account can operate Pan Ctrl and system function, BAK and senior right is disabled.

|           |          |   |
|-----------|----------|---|
| User:1    | Pan Ctrl | ● |
| Pwer:User | System   | ● |
|           | BAK      | ○ |
|           | Senior   | ○ |

#### 4.3.3 Set Local as Default

Here is for you to restore factory default setup.

Note: when you operate this function, please be careful!

|                       |
|-----------------------|
| Set Local as Default? |
| Yes: ENTER No: Esc    |

#### 4.3.4 Empty Control Point

Here is for you to delete all control point information.

Click ENTER to clear all.

|  |
|--|
| Clear ALL CTL Point?<br>Yes: ENTER No: Esc |
|--|

#### 4.4 Assistant Setup

Assistant setup includes the following items:

|  |
|--|
| Back light: ON<br>Alarm: ON<br>Language: English |
|--|

##### 4.4.1 Backlight Setup

You can open LCD backlight. It will last for ten minutes.

When you log in the next time, backlight automatically turns on

##### 4.4.2 Alarm Setup

You can turn on alarm function.

##### 4.4.3 Language

There are three options: English/Simplified Chinese/Traditional Chinese.

##### 4.4.4 Auto Lock

Here is for you to set auto lock interval. There are four options:10/30/60/close(Unit: minute).

When keyboard is inactive for specified interval, it becomes locked. You need to log in again to operate keyboard.

Close means disable auto lock function, keyboard always maintain active.

#### 4.5 System Information

System information includes the following items.

- Version: here is to display system version.(for reference only)
- Date: here is to display system released date(for reference only)
- Connection type: here is to display current connection type.  
You can click ENTER to view type (serial port or network)
- Point information

|  |
|--|
| Version: 1.10<br>Date: 2006-12-29<br>Connection type: Network<br>Point Info: 0 |
|--|

##### 4.5.1 Search Point

You can input either of the following information to search one device. System can automatically connect with that device and you can use keyboard to control it.

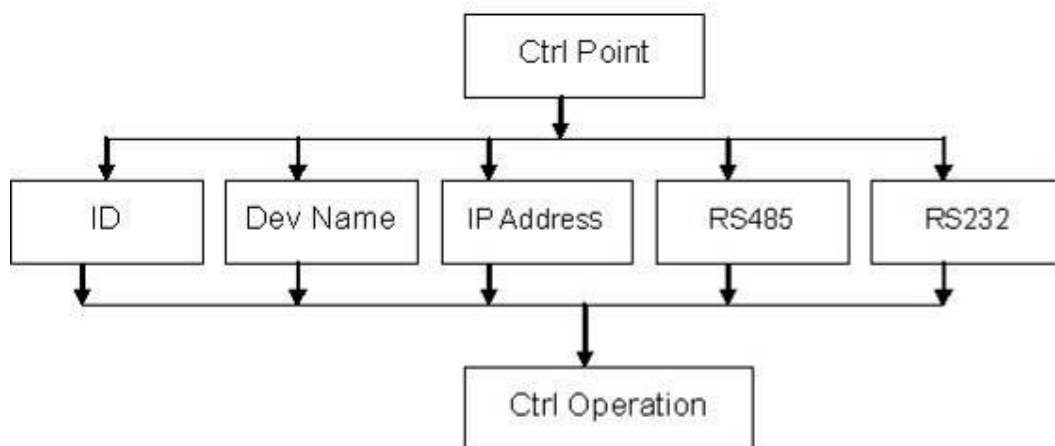

You can click ENTER to go to the above menu and then input corresponding property to search.

E.g.: If you want to search a device of ID3. Input ID as 3 and then click ENTER to confirm.

System pops up the following interface, ID 3 is a dome and its RS232 address is 3. System automatically connects the dome. Now you can use keyboard to control current dome.

```

Current Dev: Dome
RS232: 3

ID: 3
  
```

Note: when you use keyboard to control DVR, please click ID and then click ESC to go back to previous menu.

When you use keyboard to control other device, click ESC to go back to previous menu.

## 5 Keyboard Control DVR

### 5.1 Serial Port Connection

#### 5.1.1 RS232 Serial Port Connection

Use one RS232 cable to connect DVR serial port and keyboard serial port together. DVR address number ranges from 1 to 255, please refer to DVR manual for more information.



#### 5.1.2 Via RS485 Connection

One RS232 port can only connect with one DVR.

You need to use RS 485 port once you want to control more than one DVRs.

You can use one standard RS485 to RS 232 box connect with DVR 232 port.

RS 485 port pins definition:

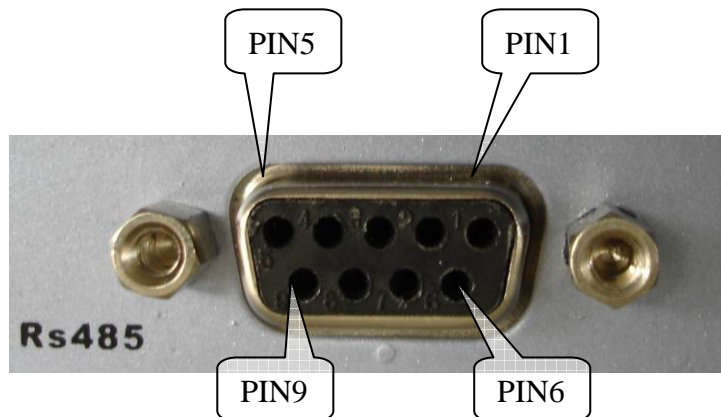

PIN1 : +5V power supply

PIN2 : Alarm output

PIN3 : RS485 A line

PIN4 : Blank

PIN5 : GND

PIN6 : Alarm input

PIN7 : RS485 A line

PIN8 : RS485 B line

PIN9 : RS485 B line

## Rs485 connection via converter

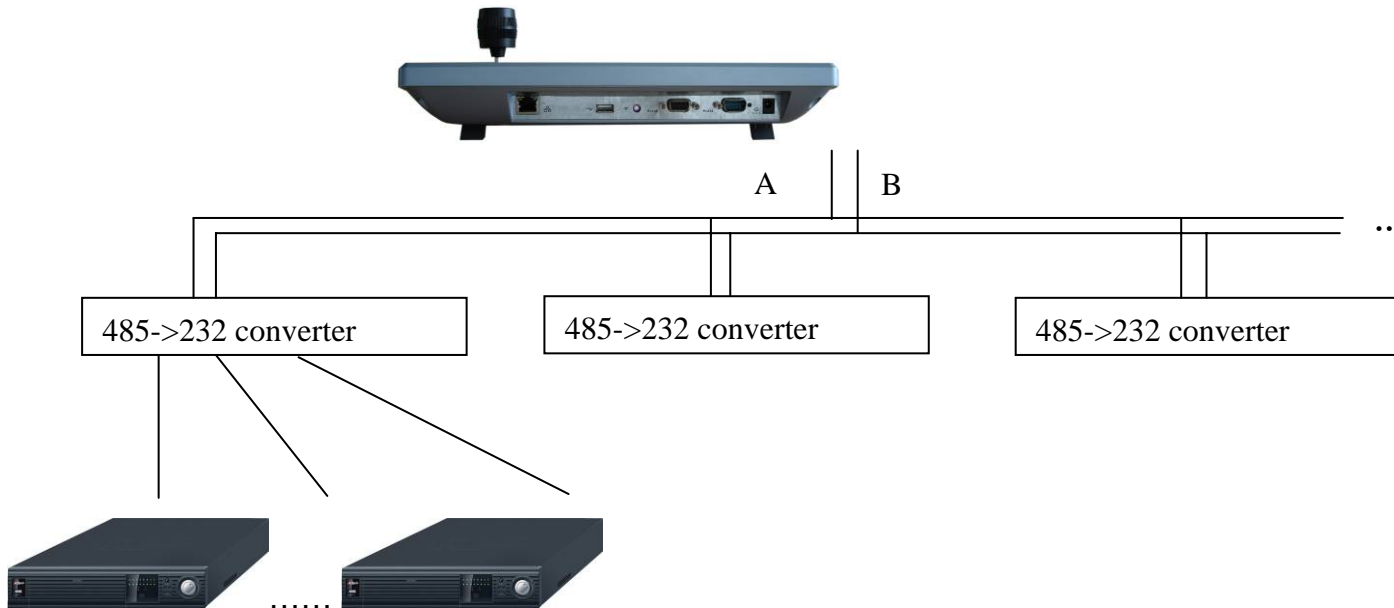

One 485 bus can connect with thirty-two RS485->232 converters, one RS485->232 converter can connect with twelve DVRs.

### 5.1.3 Multi-keyboard Level-link via RS485



#### Multi-converter connection:

The last converter on RS 485 port must be short circuited. (E.g.: open converter). See the image below, you need to change [1-2] short circuit to [2-3] short circuit.

Note:

Menu serial setup should conform to the device you connected; otherwise keyboard can not control the device!

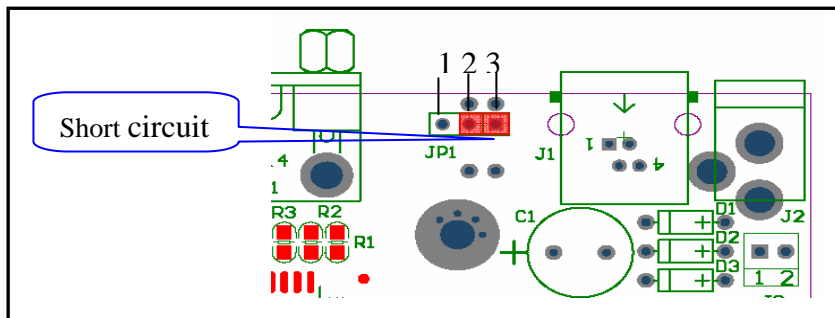

## 5.2 Network Connection (For Network Keyboard Only)

Connect RJ45 port to the network to realize network control, upgrade and USB backup.

### 5.2.1 RJ45 port connection

#### 5.2.1.1 Direct connection



#### 5.2.1.2 Connect via Switch

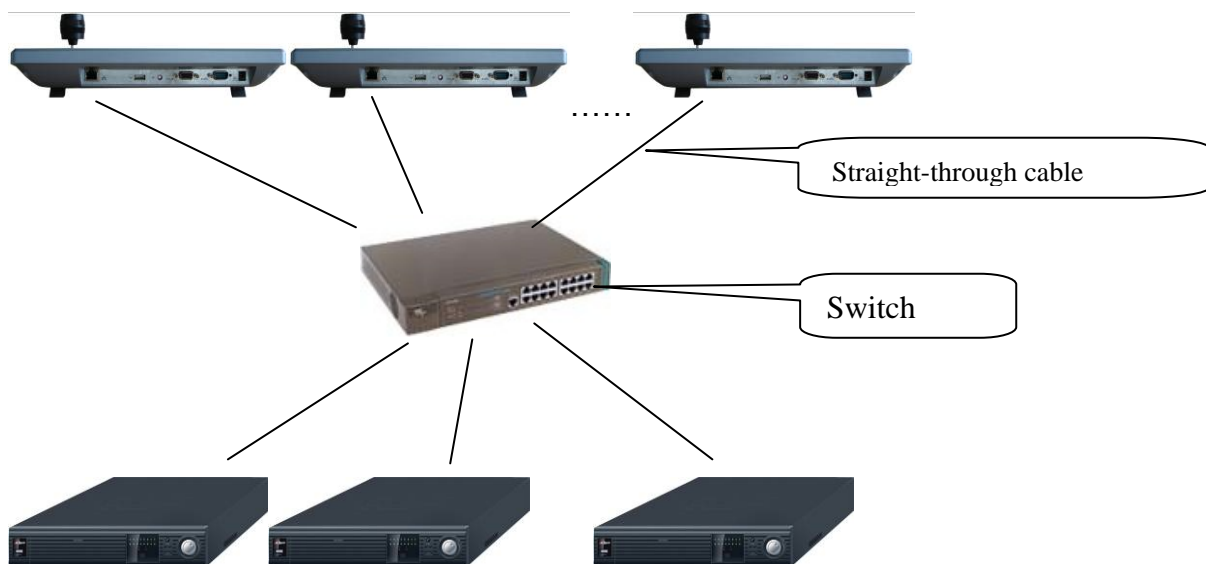

## 5.3 DVR and Keyboard Setup

### 5.3.1 DVR Setup

Before operation, please make sure cable connection is proper.

In DVR menu, from "Setting" to RS232, the default setup is shown as below.

- Function: network keyboard
- Baud rate: 9600
- Data bit: 8
- Stop bit: 1
- Parity: none.

Please note keyboard setup should conform to DVR setup.

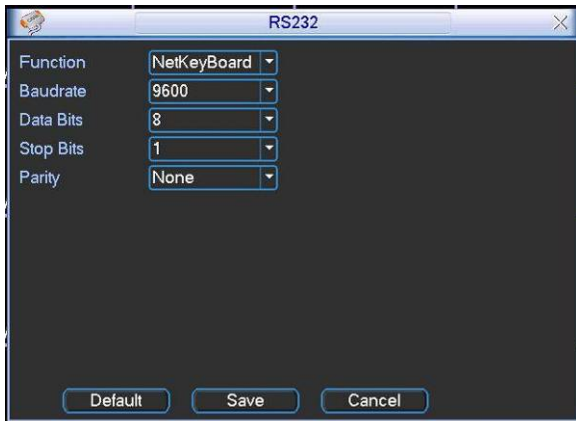

### 5.3.2 Keyboard Setup after Serial Port Connection

In menu, go to control point setup. Here you need to input the following information.

|                        |
|------------------------|
| ID: *3                 |
| Dev name: DVR-1        |
| Dev type: DVR          |
| Connection type: RS232 |

- ID:

If there is a \* before the ID number (such as \*3), it means this front device has control point setup.

You can view device \*3 corresponding type and name.

- Device name:

Here is for you to give a name to the front device.

- Device type

There are several selections such as DVR/Dome/CMS/NVS. You can use left/right key to

select device type and then click up/down to go on setup.

- Connection type

Please use up/down to highlight connection type and then use left/right to select type.

Click "ENTER" to set the following items:

- 232 address
- Parity
- Protocol
- Stop bit
- Baud rate
- Data bit

|                 |              |
|-----------------|--------------|
| 232 Add: 8      | Parity: None |
| Protocol: DH2   | Stop bit: 1  |
| Baud rate: 9600 |              |
| Data bit: 8     |              |

Note: 232 address and 485 address are corresponding DVR local number.  
DH2 is network keyboard/2<sup>nd</sup> generation control keyboard protocol, its corresponding DVR serial port protocol is network keyboard protocol.  
DH1 is the first generation keyboard protocol, its corresponding DVR serial port is control keyboard protocol or Dahua protocol.

### 5.3.3 Keyboard Setup after Network Connection

ID, device name and device type setup please refer to 6.3.2.

Use up/down to highlight connection type and then use left/right to select connection type.

Click "ENTER" to go to setup.

After all the setup, click ESC to exit. System pops up the dialogue box to prompt you save setup

|                              |
|------------------------------|
| CTL point IP"192.168.090.111 |
| CTL port: 3777               |
| Protocol"DH-2                |

|                    |
|--------------------|
| Save data?         |
| YES: ENTER NO: ESC |

## 5.4 Operation

### 5.4.1 Login

You can use the following ways to login: ID, device name, IP, 232 address, 485 address.

Click ENTER to go to setup interface, input you information and click ENTER to begin search.

System automatically begin login if search is OK.

System pops up the alert information if there is no search result.

Note:

Before you login, please log off DVR local user menu, local user priority is higher than the keyboard user!

|          |         |
|----------|---------|
| ID       | 485 Add |
| Dev name |         |
| IP ADD   |         |
| 232 ADD  |         |

### 5.4.2 Logout

Click ID key and then click ESC, you can logout current control menu.

### 5.4.3 Record

Click record button (●) to go to record interface. You can use direction keys to modify channel name and status. Click ENTER to save modification, click ESC to exit without saving modification you have done.

#### 5.4.4 PTZ Control and Image Color

In single window display mode, click Fn1, system pops up PTZ and image color menu. Or you can click P/T in the keyboard to go to DVR control menu.

#### 5.4.5 Tour and Single/Multiple Window Switch.

Note: before click tour key, please make sure your current series DVR supports tour function.

You can click tour key (⤴) to begin touring.

□、田、■、■ are corresponding to :One/four/nine/sixteen window display modes.

You can click numeral key to go to corresponding channel. E.g. you can click numeral 1 to go to channel one.

For channel number more than two-digit (such as numeral 11), you need work with CAM key.

E.g., you want to go to channel 12 then you input CAM+12+CAM.

#### 5.4.6 Network keyboard backup (USB backup)

Connect network keyboard RJ45 port with DVR. Please refer to 6.2 Network Connection.

You can follow the procedures below:

- Insert external hard disk into USB port.
- After successfully login, click AUX1 in the keyboard. You can see the interface,

|                                    |
|------------------------------------|
| Date: Year: 2006 Month: 09 Day: 20 |
| Start: H: 08 M: 30 S: 00           |
| End: H: 17 M: 30 S: 00             |
| Ch: 1 Type: Recording              |

- Date
- Start time
- End time
- Channel name
- Video type: recording/alarm/motion detection/card number

- After setup, please click ENTER. Network keyboard sends search results to DVR. You can see the following interface if there are matched results.

|                          |
|--------------------------|
| NO.1-0 08:30:01 09:30:30 |
| NO.1-1 09:30:01 10:30:00 |
| NO.1-2 10:30:00 11:30:00 |
| NO.1-3 11:30:00 12:30:00 |
| NO.1-4 12:30:00 13:30:00 |

- Please use up/down to select one path to save video files.

X here range from 0 to 4. Click ENTER to save video and system pops up process bar.

Download NO.X file ?  
YES: ENTER, NO: ESC

If there is no USB device connected, system pops up message to alert you.

No USB device connected  
OK

## 6 Network Keyboard Control Dome

### 6.1 Cable Connection

Please make sure keyboard AB line and dome AB line connection is right. Connect dome to power, and then connect dome video cable to the monitor. Before operating, please go to dome menu to go on setup. If dome address is 1, then keyboard RS 485 address is 1.

### 6.2 Keyboard Setup

In keyboard menu, go to control point. Here you can input ID, device name. You can use left/right key to select device type. Use up/down to highlight connection type, then click ENTER to go to RS 485 setup. 485 address is 1, default protocol is DH-SD. You can select in accordance with you actual demands. After all the setup, click Enter to save setup or you can click ESC to exit without saving the modification you have done.

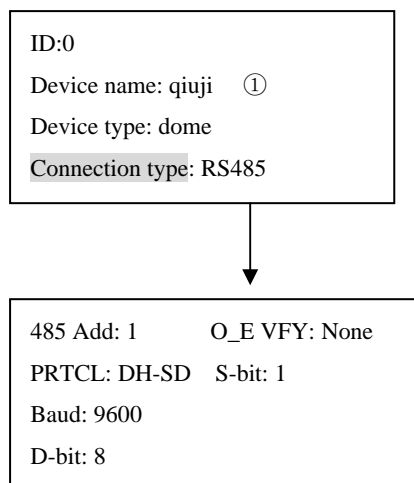

### 6.3 Operation

Before operation please note:

- X value varies due to different protocols.
- Please use up/down to move dome operation menu.
- Use left/right to move cursor.
- All the operation here is based on DH-SD protocol. There may be some difference for various protocols.

Now you can click ID key and input ID number to enter current device connection interface.

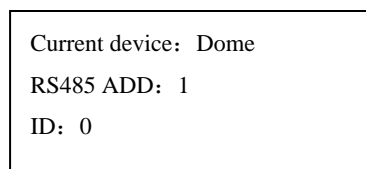

Click MENU, the interface is shown as below.  
The menu here should work with dome menu.

|          |                 |
|----------|-----------------|
| 1. up    | 5.Previous menu |
| 2. down  | 6.Next menu     |
| 3. Left  | 7.Confirm       |
| 4. Right | 8.Exit          |

### 6.3.1.1 Speed

It is to control direction. The value ranges from one to eight. Please use the number buttons of the keyboard to input value (between 0~8) and press ENTER

to confirm. (Operation here is only active with key-press. You can use joystick to control speed directly. )

PTZ movement direction

- For joystick: up/down/left/right/up left/right down/up right/left down.
- For keyboard: up/down/left/right

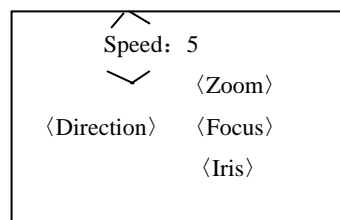

### 6.3.1.2 Zoom/focus/Iris

- Zoom: please use WIDE and TELE to control PTZ zoom.
- Focus: please use FAR and NEAR to control PTZ focus.
- Iris: Please use CLOSE and OPEN to control PTZ aperture.

You can use joystick to control lens, clockwise is to zoom out and anti-clockwise is to zoom in.

## 6.3.2 Preset

### 6.3.2.1 Preset setup

After zoom and PTZ setup, input value and click ENTER to confirm.

Now you have set one preset.

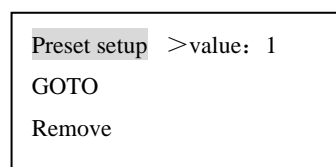

### 6.3.2.2 GOTO

Move cursor to highlight GOTO.

Input preset value and click ENTER.

System goes to specified preset.

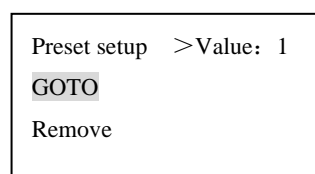

### 6.3.2.3 REMOVE

Move cursor to highlight REMOVE. Input preset value and click ENTER.

Now you have removed one preset.

**Note: Some protocols do not support remove preset function. You can modify to replace the previous one.**

## 6.3.3 Scan

### 6.3.3.1 Scan setup

①、 Input value and then move cursor to highlight left limit.

Or you can use joystick to move camera to left limit and then click ENTER.

②、 Repeat procedure one to set right limit.

③、 Move cursor to highlight speed. Input speed value and click ENTER to confirm.

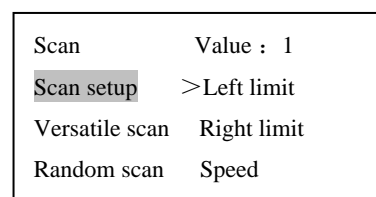

### 6.3.3.2 Scan operation

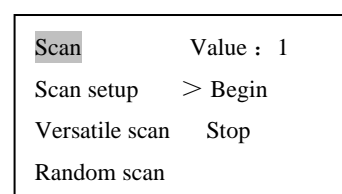

- ④、 Use up/down to highlight scan. Input scan value and click ENTER to begin scanning.
- ⑤、 Use left/right keys to highlight stop. Click ENTER to stop scanning.

**Note: for versatile scan and random scan, you need corresponding protocols to support.**

### 6.3.4 Tour

#### 6.3.4.1 Tour setup

Use up/down keys to highlight add to tour. Input value in tour group.

For example, here we want to add tour point 2 and 3 in tour group 1.

- Firstly, input 1 in tour group.
- Secondly, input 2 to tour and then click ENTER.

Now you have added tour point 2 to tour group 1.

- Thirdly, input 3 to tour and then click ENTER.

Now you have added tour point 3 to tour group 1.

You can repeat the above procedures to add more tour point.

#### 6.3.4.2 Tour operation

- Speed

Please use up/down keys to highlight tour setup.

When cursor is before speed, you can input speed value.

- Duration

Use left/right keys to highlight duration and then you can input interval value.

- Begin touring

Use up/down to highlight tour and then input value.

Now you can click ENTER to begin tour.

- Stop touring

Move cursor to highlight stop and then click ENTER. Now you have stopped touring

#### 6.3.4.3 Remove

##### 6.3.4.3.1 Remove tour

Move cursor to highlight remove tour and then input corresponding value.

Click ENTER to delete current tour.

##### 6.3.4.3.2 Remove tour point

- Move cursor to highlight tour group and then input corresponding value.
- Please click Enter to confirm all the operation below is active to current tour group.
- Move cursor to highlight tour point and input corresponding value (such as 2).
- Now click ENTER to delete.

For example, you want to remove tour point 5 and 6 from tour group 2.

|                |           |
|----------------|-----------|
| Scan           | Value : 1 |
| Scan setup     | > start   |
| Versatile scan | Stop      |
| Random scan    | Speed     |

|             |                 |
|-------------|-----------------|
| Tour        |                 |
| Tour setup  | > Tour group: 1 |
| Add to tour | Tour:           |
| Remove tour |                 |



|             |                   |
|-------------|-------------------|
| Tour        | Value : 1         |
| Tour setup  | > Speed           |
| Add to tour | Duration          |
| Remove tour | Remove tour group |



|             |           |
|-------------|-----------|
| Tour        | Value : 1 |
| Tour setup  | > Start   |
| Add to tour | Stop      |
| Remove tour |           |

|             |                     |
|-------------|---------------------|
| Tour        | Value : 1           |
| Tour setup  | Speed               |
| Add to tour | Duration            |
| Remove tour | > Remove tour group |

|                   |                 |
|-------------------|-----------------|
| Tour              |                 |
| Tour setup        | > Tour group: 1 |
| Add to tour point | Tour point:     |
| Remove tour point |                 |

- Firstly, input 2 in tour group and click ENTER.
- Secondly, input 5 in tour point and click ENTER. Now you have deleted tour point 5.
- Thirdly, input 6 in tour point and click ENTER. You have deleted tour point 6.

### 6.3.5 PATTERN

#### 6.3.5.1 Pattern setup

- Move cursor to highlight pattern and then input pattern value. Input value is the pattern path you want to set (Maximally support five paths). Click ENTER to confirm.
- Move cursor to highlight start and then input pattern value. Now click ENTER to confirm.
- Move cursor to highlight stop. Input pattern value and click ENTER to stop pattern. Dome will automatically memorize all the operations you have done.

|                     |          |
|---------------------|----------|
| Pattern             | Value: 1 |
| <b>Patter setup</b> | > Start  |
| Rotation            | Stop     |

|                |          |
|----------------|----------|
| <b>Pattern</b> | Value: 1 |
| Pattern setup  | >Start   |
| Rotation       | Stop     |

#### 6.3.5.2 Pattern operation

- Please use up/down keys to highlight pattern. When cursor is before start, please input pattern value and then click ENTER to begin patterning.
- Move cursor to highlight stop and then click ENTER. System stop pattern.

### 6.3.6 Pan Rotation

Move cursor to highlight speed. Input speed value (the speed you want) and click ENTER.

Then move cursor to highlight start and then click ENTER. Dome begins pan rotation.

Move cursor to highlight stop and then click ENTER. Dome stops rotation.

|                     |          |
|---------------------|----------|
| Pattern             | Value: 1 |
| Pattern setup       | Start    |
| <b>Pan rotation</b> | Stop     |
|                     | >Speed   |

### 6.3.7 Light/Wiper/Assistant/Fan Setup

Move the cursor to highlight enable, click ENTER to enable or disable current function.

Move the cursor to highlight disable and then click ENTER to exit current menu.

|                    |          |
|--------------------|----------|
| <b>Light Setup</b> |          |
| Wiper Setup        | > Enable |
| Assistant Setup    | Disable  |
| Fan Setup          |          |

## 7 Network Keyboard Upgrade

Before upgrade, please make sure your network keyboard is well connected. You can use command “PING” to test network connection, the return value TTL should be less than 255.

Please download upgrade file to your local PC. You can download upgrade file from our website or from our local service engineer.

Double click RECUpgrade.exe to begin upgrade.

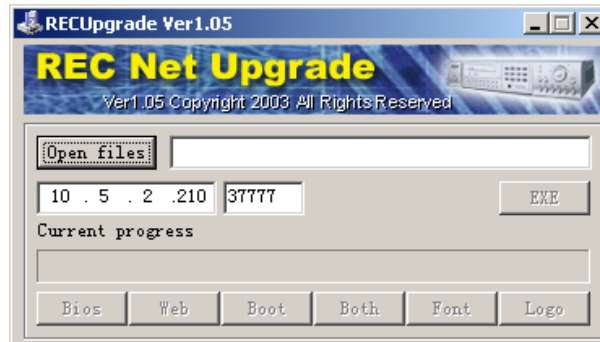

Please input network keyboard IP address and port. Then click open files button to select upgrade file.

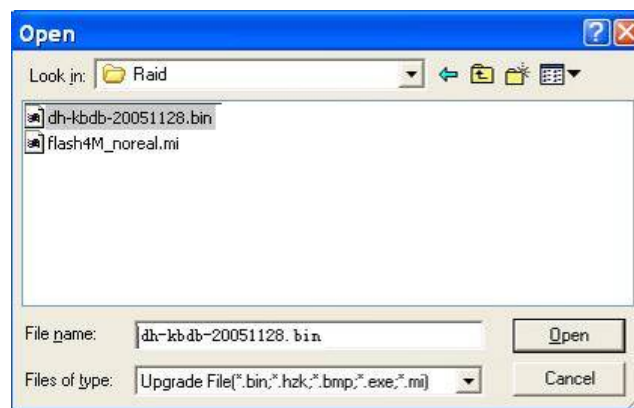

After selection, click open to add current file to the address column.

System automatically recognizes upgrade file, you can click BIOS button to begin upgrade. System pops up upgrade process bar for your reference.

After successful upgrade, click OK to finish operation.



**Tips:**

Use you mouse to click the upgrade file; drag it to the “open files” column and then release.  
You can see the file path and current file is open.  
System pops up alert information if it is not keyboard upgrade file.

## 8 Make Serial Port

Keyboard standard accessories package includes the following items.

- One DB9
- Seven DB9
- One six-pin crystal port
- One 25-pin (DB25)
- One 485 transmission box. (Including one power source.)

### 8.1 RS232 Serial Port



232 serial port  
(DB9)

232serial port  
(DB9)

### 8.2 485 Port

RS485 port of DVR

(DB9)

Keyboard 485 port  
(6-pin crystal spot)



Keyboard and 485 switch box connection

### 8.3 25-pin Port and Switch Box Connection

Connect switch 25-pin box RS232 port with DVR RS232 port. (25-pin outlet supports maximum twelve RS232 ports. Switch is just for sending not for receiving. So you can use two cables: GND and TXD)

485switch box 25-pin port  
(DB25)

232 port  
(DB9)

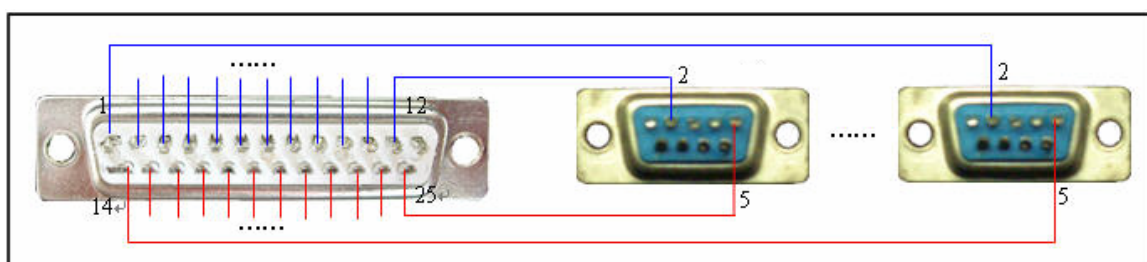

## 485 switch box and DVR connection

Note: you can use standard RS232 port to connect keyboard with DVR.

**Slight difference may be found in user interface.**

**All the designs and software here are subject to change without prior written notice.**

**Please visit our website for more information.**